









































# Light Bulbs + Sockets

Prices see **Main Assortment**  
[shop.griederbauteile.ch](http://shop.griederbauteile.ch)



Prices see **Treasure Trove**  
[shop.griederbauteile.ch](http://shop.griederbauteile.ch)



|  |                                       |  |   |   |   |
|--|---------------------------------------|--|---|---|---|
| <b>E10</b><br><b>Multi LED</b>   | <b>Page 2 - 3</b><br><b>Page 3</b>    |    |    |    |    |
| <b>E5/8 + E5.5/16</b><br><b>E14</b>  | <b>Page 4</b>                         |    |    |    |    |
| <b>E27 + E40 (Projection Lamps)</b><br><b>T2 Ba7s</b>  | <b>Page 5</b>                         |    |    |    |    |
| <b>Ba9s</b><br><b>Ba15s + Ba15d</b>  | <b>Page 6 + 7</b><br><b>Page 7</b>    |    |    |    |    |
| <b>Ba20s + Ba20d</b>   | <b>Page 8</b>                         |    |    |    |   |
| <b>T<sup>3</sup>/<sub>4</sub></b><br><b>T1</b>   | <b>Page 8 + 9</b>                     |   |   |   |   |
| <b>T<sup>1</sup>/<sub>4</sub> + T1<sup>1</sup>/<sub>2</sub> + T1<sup>3</sup>/<sub>4</sub></b><br><b>Special Bulbs + Wedge Base</b> | <b>Page 9 - 13</b><br><b>Page 14</b>  |  |  |  |  |
| <b>LED Lamps + Projection Lamps</b><br><b>Halogen + Fluorescent</b>  | <b>Page 15</b><br><b>Page 16</b>      |  |  |  |  |
| <b>Festoon</b><br><b>Telecommunication Bulbs</b>   | <b>Page 17</b><br><b>Page 17 - 20</b> |  |  |  |  |
| <b>Glow Lamps</b><br><b>Indicator Lights</b>   | <b>Page 20</b><br><b>Page 21</b>      |  |  |   |   |
| <b>Sockets</b>   | <b>Page 21 - 23</b>                   |  |  |  |  |
|  |                                       |  |   |   |   |
|  |                                       |  |   |   |   |

**Light Bulbs E10 Spherical Shape**

| Order No | Voltage | Current | Power  | Bailey Number |
|----------|---------|---------|--------|---------------|
| EBA.0110 | 1.5V    | 100mA   | 150mW  | E24001090     |
| EBA.0210 | 2.5V    | 100mA   | 250mW  | E24001100     |
| EBA.0230 | 2.5V    | 300mA   | 750mW  | E24002300     |
| EBA.0407 | 3.8V    | 80mA    | 266mW  | E24003070     |
| EBA.0430 | 3.8V    | 300mA   | 1140mW | E24003301     |
| EBA.0605 | 6V      | 50mA    | 300mW  | E24006050     |
| EBA.0610 | 6V      | 100mA   | 600mW  | E24006100     |
| EBA.0630 | 6V      | 300mA   | 1800mW | E24006300     |
| EBA.1205 | 12V     | 50mA    | 600mW  | E24012050     |
| EBA.1210 | 12V     | 100mA   | 1200mW | E24012100     |
| EBA.1225 | 12V     | 250mA   | 3W     | E24012250     |
| EBA.2402 | 24V     | 20mA    | 480mW  |               |
| EBA.2405 | 24V     | 50mA    | 1200mW | E24024050     |
| EBA.2412 | 24V     | 125mA   | 3W     | E24024125     |
| EBA.3602 | 36V     | 20mA    | 720mW  |               |
| EBA.3605 | 36V     | 50mA    | 1800mW | E24036050     |
| EBA.3608 | 36V     | 83mA    | 3W     |               |
| EBA.4802 | 48V     | 20mA    | 960mW  |               |
| EBA.4804 | 48V     | 40mA    | 1920mW |               |
| EBA.4806 | 48V     | 63mA    | 3W     |               |
| EBA.6002 | 60V     | 20mA    | 1200mW |               |
| EBA.6004 | 60V     | 40mA    | 2400mW |               |

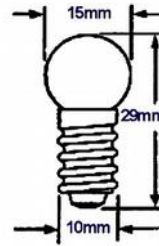

**Light Bulbs E10 Cylindrical Shape**

| Order No  | Voltage    | Current | Power | Bailey Number |
|-----------|------------|---------|-------|---------------|
| EBB.0230  | 2.5V       | 300mA   | 850mW | E28002300     |
| EBB.0406  | 4V         | 60mA    | 240mW |               |
| EBB.0410  | 4V         | 100mA   | 400mW | E28004100     |
| EBB.0430  | 4V         | 300mA   | 1.2W  | E28004300     |
| EBB.H0450 | 4V Halogen | 500mA   |       | Osram 6405730 |
| 13.04040  | 4V         | 40mA    |       |               |
| EBB.0460  | 4V         | 600mA   | 2.4W  | E28004600     |
| 13.45150  | 4.5V       | 150mA   |       |               |
| EBB.0602  | 6V         | 20mA    | 120mW |               |
| EBB.0603  | 6V         | 30mA    | 180mW |               |
| EBB.0605  | 6V         | 50mA    | 300mW | E28006050     |
| EBB.0610  | 6V         | 100mA   | 600mW | E28006100     |
| 13.06180  | 6V         | 180mA   |       |               |
| EBB.0630  | 6V         | 300mA   | 1.8W  | E28006300     |
| EBB.0650  | 6V         | 500mA   | 3W    | E28006500     |
| EBB.0683  | 6V         | 830mA   | 5W    | E28006830     |
| EBB.0710  | 7V         | 100mA   | 700mW | E28007100     |
| EBB.0730  | 7V         | 300mA   | 2.1W  | E28007300     |
| EBB.1202  | 12V        | 20mA    | 240mW | E28012020     |
| EBB.1205  | 12V        | 50mA    | 600mW | E28012050     |
| EBB.1210  | 12V        | 100mA   | 1.2W  | E28012100     |
| EBB.1217  | 12V        | 170mA   | 2.04W | Osram 3453    |
| EBB.1225  | 12V        | 250mA   | 3W    | E28012250     |
| 13.12950  | 12V        |         | 5W    |               |
| 13.19120  | 19V        | 120mA   |       |               |
| EBB.2402  | 24V        | 20mA    | 480mW |               |
| EBB.2405  | 24V        | 50mA    | 1.2W  | E28024050     |
| EBB.2408  | 24V        | 80mA    | 1.92W | E28024080     |
| 13.24080  | 24V        | 80mA    |       |               |
| EBB.2412  | 24V        | 125mA   | 3W    | E28024125     |
| 13.24030  | 24V        |         | 3W    |               |
| EBB.2805  | 28V        | 50mA    | 1.4W  | E28028050     |
| EBB.2810  | 28V        | 107mA   | 3W    | E28028100     |
| EBB.3602  | 36V        | 20mA    | 720mW |               |
| EBB.3605  | 36V        | 50mA    | 1.8W  | E28036050     |
| EBB.3608  | 36V        | 83mA    | 3W    |               |
| EBB.4802  | 48V        | 20mA    | 960mW | E28048020     |
| EBB.4804  | 48V        | 40mA    | 1.92W | E28048040     |
| EBB.4806  | 48V        | 63mA    | 3W    | E28048060     |
| EBB.6002  | 60V        | 20mA    | 1.2W  | E28060020     |
| EBB.6004  | 60V        | 40mA    | 2.4W  | E28060040     |
| EBB.6008  | 60V        |         | 5W    |               |



**Light Bulbs (Torch Bulbs) E10 Spherical Shape**

| Order No | Voltage | Current | Power | Dimensions |
|----------|---------|---------|-------|------------|
| 05.25301 | 2.5V    | 300mA   |       | 11 x 28mm  |
| 05.38300 | 3.8V    | 300mA   |       |            |
| 05.38301 | 3.8V    | 300mA   |       |            |
| 06.06930 | 6V      |         | 3W    | 15 x 27mm  |



**Intermittent Light Bulbs E10 Spherical**

| Order No | Voltage | Current | Power  | Dimensions |
|----------|---------|---------|--------|------------|
| EBD.02   | 2.5V    | 300mA   | 750mW  | 15 x 29mm  |
| EBD.03   | 3.5V    | 300mA   | 1050mW |            |
| EBD.06   | 6V      | 500mA   | 3W     |            |
|          |         |         |        |            |
|          |         |         |        |            |
|          |         |         |        |            |

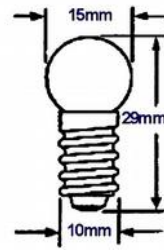

**Intermittent Light Bulbs E10 Cylindrical**

| Order No | Voltage | Current | Power  | Dimensions |
|----------|---------|---------|--------|------------|
| EBF.02   | 2.5V    | 300mA   | 750mW  | 10 x 28mm  |
| EBF.03   | 3.5V    | 300mA   | 1050mW |            |
| EBF.05   | 5.3V    | 500mA   | 2650mW |            |
|          |         |         |        |            |

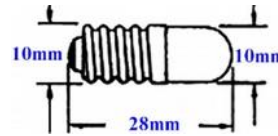

**Lenticular Light Bulbs 6/9 Bantam E10**

| Order No | Voltage | Current | Power  | Bailey Number |
|----------|---------|---------|--------|---------------|
| EBC.0122 | 1.2V    | 220mA   | 264mW  | EL0120220     |
| 07.22180 | 2.2V    | 180mA   |        | Philips 7067D |
| EBC.0220 | 2.5V    | 200mA   | 2500mW | EL0250200     |
| EBC.0230 | 2.5V    | 300mA   | 750mW  | EL0250300     |
| EBC.0430 | 3.7V    | 300mA   | 1110mW | EL0370300     |
|          |         |         |        |               |

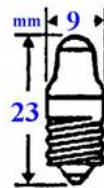

**Misc Light Bulbs with E10 Socket**

| Order No    | Voltage | Current | Dimensions | Description        |
|-------------|---------|---------|------------|--------------------|
| 20.37300    | 3.7V    | 300mA   | 9.5x24mm   | Osram 3644         |
| 87.59850    | 5.2V    | 850mA   | 9.3x31mm   | Halogen            |
| 86.06960    | 6V      | 1A/6W   | 15x28mm    | Automotive bulb    |
| LE.E.0645WA | 6V      | 20mA    | 9.7x24.7mm | 8mm LED light bulb |
| 12.60020    | 60V     | 20mA    | 8.5x23mm   | Signal lamp        |
| EBA.3403K   | 34V     | 3W      | 13.5x45mm  | Candle shape       |



**Neon Glow Lamps E10 Cylindrical 10x28mm**

| Order No | Voltage | Description                                     |
|----------|---------|---|
| EBB.G110 | 110V    | T3-¼, 10x28mm, w ith built-in dropping resistor |
| EBB.G220 | 220V    |   |
| EBB.G380 | 380V    |   |



**Glow Lamps E10 Cylindrical Shape**

| Order No | Voltage  | Description           | Dimensions |
|----------|----------|-----------------------|------------|
| 70.12110 | 110V     | Neon                  | 10 x 25mm  |
| 70.13139 | 110-130V | Neon                  | 10 x 28mm  |
| 70.13226 | 220V     | Yellow coloured glass |            |
| 70.13227 | 220V     | Red coloured glass    |            |
| 70.13229 | 220V     | Signal colour green   |            |
| 70.13223 | 220V     | Blue                  |            |
| 70.13222 | 220V     | Red (fluorescent)     |            |
| 70.13224 | 220V     | Signal colour w hite  |            |
| 70.13382 | 380V     | Red (fluorescent)     |            |

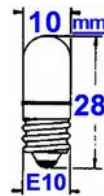

**Multi LED with E10/14 Socket**

| Order No | Voltage | Description       | Dimensions |
|----------|---------|-------------------|------------|
| 85.8824A | 24V     | With 8 yellow LED | 11 x 20mm  |
| 85.8824G |         | With 8 green LED  |            |
| 85.8724G |         | With 8 green LED  |            |
| 85.8824R |         | w ith 8 red LED   |            |
|          |         |                   |            |



**Multi LED with E12/15 Socket**

| Order No | Voltage | Description          | Type       |
|----------|---------|----------------------|------------|
| 85.8924A | 24V     | Mit 8 gelben LED     | LD0807A24A |
| 85.9024A |         | Mit 8 gelben LED     | LD0807D24A |
| 85.9024G |         | Mit 8 grünen LED     | LD0807D24A |
| 85.9024M |         | Mit 8 gemischten LED | LD0807D24M |
| 85.9024R |         | Mit 8 roten LED      | LD0807D24R |
|          |         |                      |            |
|          |         |                      |            |

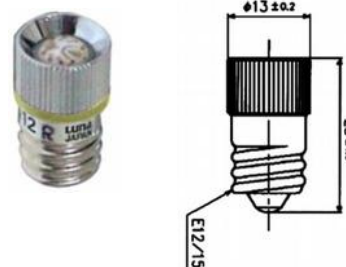

**Miniature Light Bulbs E5/8 + E5.5/16**

| Order No | Voltage | Current | Socket           |
|----------|---------|---------|------------------|
| 44.25250 | 2.5V    | 250mA   | E5/8 LES         |
| 44.25300 | 2.5V    | 300mA   | E5/8 LES         |
| 44.25400 | 2.5V    | 400mA   | E5/8 LES         |
| 44.03015 | 3V      | 15mA    | E5/8 LES         |
| 44.03200 | 3.5V    | 200mA   | E5/8 LES         |
| 44.45200 | 4.5V    | 200mA   | E5/8 LES         |
| 44.06020 | 6V      | 20mA    | E5.5/16 (6x21mm) |
| 44.06100 | 6V      | 100mA   | E5/8 LES         |
| 44.12060 | 12V     | 60mA    | E5/8 LES         |
| 44.12120 | 12V     | 120mA   | E5.5/16 (6x21mm) |
| 44.14000 | 14V     | ??      | E5/8 LES         |
| 44.14040 | 14V     | 40mA    | E5/8 LES         |
| 44.24050 | 24V     | 50mA    | E5.5/16 (6x21mm) |
| 44.24060 | 24V     | 60mA    | E5/8 LES         |

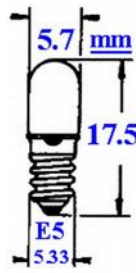

E5/8 LES



E5.5/16



**Incandescent Bulbs with E14 Socket**

| Order No  | Voltage  | Power  | Measure | Description     |
|-----------|----------|--------|---------|-----------------|
| 76.06180  | 6V       | 180mA  | 13x30mm |                 |
| 83.06945  | 6V       | 4.5A   | 35x67mm | Spherical Shape |
| 79.06950  | 6V       | 5W     | 16x54mm |                 |
| 79.12950  | 12V      | 5W     | 16x54mm |                 |
| 79.24950  | 24V      | 5W     | 16x54mm |                 |
| 83.24911  | 24V      | 10W    | 26x54mm | Tapered Shape   |
| 89.24926  | 24V      | 25W    | 20x85mm |                 |
| 78.36950  | 36V      | 5W     | 16x35mm |                 |
| 76.48930  | 48V      | 3W     | 13x30mm |                 |
| 79.60950  | 60V      | 5W     | 16x54mm |                 |
| 83.22060  | 60V      | 40W    |         | Kerzenform      |
| 83.12925  | 110-120V | 25W    | 26x54mm |                 |
| 80.15010  | 150V     | 10W    | 26x52mm | Tapered Shape   |
| 78.260007 | 220-260V | 5-7W   | 16x35mm |                 |
| 80.26057  | 220-260V | 5-7W   | 16x48mm |                 |
| 80.26071  | 220-260V | 7-10W  | 16x48mm |                 |
| 83.26097  | 220-260V | 7-10W  | 26x52mm | Tapered Shape   |
| 83.26096  | 220-260V | 7-10W  | 22x48mm | Tapered Shape   |
| 83.22910  | 220-260V | 10W    | 22x60mm |                 |
| 83.26099  | 220-260V | 10-15W | 22x48mm | Konische Form   |
| 83.22016  | 220-260V | 15W    | 26x60mm | Konische Form   |
| 89.22015  | 220V     | 15W    | 22x50mm | Backofen 300°C  |
| 83.22920  | 220-240V | 20W    | 25x70mm |                 |
| 83.22921  | 220-240V | 20W    | 25x70mm | Backofen 300°C  |
| 83.22926  | 220V     | 25W    | 25x70mm |                 |
| 83.22925  | 220-230V | 25W    | 25x62mm |                 |
| 89.22025  | 240V     | 25W    | 25x56mm | Backofen 300°C  |
| 89.22940  | 220-230V | 40W    | 45x75mm | Backofen 300°C  |
| 83.22940  | 220-250V | 40W    | 25x68mm |                 |
| 82.20940  | 220-230V | 40W    |         | Concentra R50   |



16x48mm



83.22060



83.22910



16x54mm



78.260007



83.26xxx



26x54mm



Oven Light Bulb

**Glow Lamps with E14 Socket**

| Order No | Voltage | Dimensions | Description       |
|----------|---------|------------|-------------------|
| 70.76226 | 220V    | 13x30mm    | Yellow            |
| 70.76221 |         | 14x30mm    | Fluorescent green |
| 70.79222 |         | 16x54mm    | Fluorescent red   |



**Incandescent Bulbs with E27 Socket**

| Order No | Voltage  | Power | Dimensions | Description          |
|----------|----------|-------|------------|----------------------|
| 83.12915 | 12V      | 15W   | 40x64mm    | Klar                 |
| 81.24940 | 24V      | 40W   | 60x105mm   | Matt                 |
| 83.12115 | 220V     | 15W   | 35x55mm    | Klar                 |
| 83.12215 | 220V     | 15W   | 35x55mm    | Matt                 |
| 83.12125 | 220V     | 25W   | 35x55mm    | Klar                 |
| 83.12225 | 220V     | 25W   | 35x55mm    | Matt                 |
| 82.20960 | 220-230V | 60W   | Spotlight  | Osram Concentra R63  |
| 87.22100 | 220-230V | 100W  | 47x115mm   | Halogen lamp         |
| 89.22175 | 220V     | 175W  | 122x133mm  | Philips IR175R-PAR38 |
| 87.22925 | 220V     | 250W  | 32x105mm   | Halogen lamp         |



**LED Lamps with E27 Socket**

| Order No        | Voltage | Power | Dimensions |
|-----------------|---------|-------|------------|
| LED.8WW.E27B    | 230VAC  | 7.5W  | 60x120mm   |
| LED.13WW.D.E27B | 230VAC  | 12.8W | 60x123mm   |
|                 |         |       |            |
|                 |         |       |            |
|                 |         |       |            |
|                 |         |       |            |



**Projection Lamp with E40 Socket**

| Order No | Voltage  | Power | Dimensions |
|----------|----------|-------|------------|
| 89.22500 | 220-250V | 500W  | 40x210mm   |
|          |          |       |            |
|          |          |       |            |



**T2 Light Bulbs Ba7s Socket (Midget Bayonet 7x20mm)**

| Order No | Voltage | Current | Power |
|----------|---------|---------|-------|
| ECB.0225 | 2.5V    | 250mA   | 625mW |
| ECB.0425 | 4V      | 250mA   | 1W    |
| ECB.0605 | 6V      | 50mA    | 300mW |
| ECB.0610 | 6V      | 100mA   | 600mW |
| ECB.0620 | 6V      | 200mA   | 1.2W  |
| ECB.0710 | 7V      | 100mA   | 700mW |
| ECB.1202 | 12V     | 20mA    | 240mW |
| ECB.1205 | 12V     | 50mA    | 600mW |
| ECB.1210 | 12V     | 100mA   | 1.2W  |
| ECB.1310 | 14V     | 100mA   | 1.4W  |
| ECB.2402 | 24V     | 25mA    | 600mW |
| ECB.2405 | 24V     | 50mA    | 1.2W  |
| ECB.2802 | 28V     | 25mA    | 700mW |
| ECB.2805 | 28V     | 50mA    | 1.4W  |
| ECB.3602 | 36V     | 20mA    | 720mW |
| ECB.4802 | 48V     | 20mA    | 960mW |
| ECB.6002 | 60V     | 20mA    | 1.2W  |

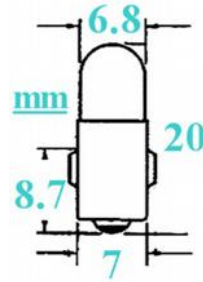

**T2 Glow Lamps Ba7s Socket (Midget Bayonet 7x20mm)**

| Order No | Voltage | Current | Dimensions | Description   |
|----------|---------|---------|------------|---------------|
| ECB.G220 | 230V    |         | 7x22mm     | Drop shape    |
| 62.48050 | 48V     | 50mA    | 7x23mm     | Tubular shape |
| 62.60020 | 60V     | 20mA    | 7x23mm     | Tubular shape |
|          |         |         |            |               |
|          |         |         |            |               |
|          |         |         |            |               |

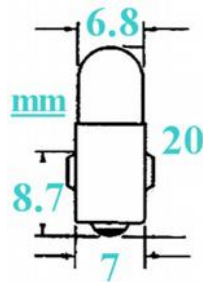



**Light Bulbs Ba9s Socket (Miniature Bayonet T3-1¼)**

| Order No  | Voltage | Current | Power | Dimensions | Description          |
|-----------|---------|---------|-------|------------|----------------------|
| ECA.0130  | 1.5V    | 300mA   | 450mW | 10x28mm    |                      |
| ECA.0230  | 2.5V    | 300mA   | 750mW | 10x28mm    |                      |
| ECA.0406  | 4V      | 60mA    | 240mW | 10x28mm    |                      |
| ECA.0410  | 4V      | 100mA   | 400mW | 10x28mm    |                      |
| ECA.0430  | 4V      | 300mA   | 1.2W  | 10x28mm    |                      |
| ECA.0460  | 4V      | 600mA   | 2.4W  | 10x28mm    |                      |
| ECA.0602  | 6V      | 20mA    | 120mW | 10x28mm    |                      |
| ECA.0605  | 6V      | 50mA    | 300mW | 10x28mm    |                      |
| 09.06070  | 6V      | 70mA    |       | 8.5x23mm   |                      |
| ECA.0610  | 6V      | 100mA   | 600mW | 10x28mm    |                      |
| 10.06200  | 6V      | 200mA   |       | 10x28mm    |                      |
| ECA.0630  | 6V      | 300mA   | 1.8W  | 10x28mm    |                      |
| ECA.0650  | 6V      | 500mA   | 3W    | 10x28mm    |                      |
| 16.06950  | 6V      |         | 5W    | 14x25mm    | Spherical shape      |
| 86.06906  | 6V      |         | 6W    | 9x29mm     | Vehicle halogen bulb |
| 10.63150  | 6.3V    | 150mA   |       | 10x28mm    |                      |
| 10.06392  | 6.3V    |         | 2W    | 10x28mm    |                      |
| ECA.0710  | 7V      | 100mA   | 700mW | 10x28mm    |                      |
| ECA.0730  | 7V      | 300mA   | 2.1W  | 10x28mm    |                      |
| ECA.1202  | 12V     | 20mA    | 240mW | 10x28mm    |                      |
| 09.12050  | 12V     | 50mA    |       | 8.5x23mm   |                      |
| ECA.1205  | 12V     | 50mA    | 600mW | 10x28mm    |                      |
| ECA.1210  | 12V     | 100mA   | 1.2W  | 10x28mm    |                      |
| ECA.1217  | 12V     | 170mA   | 2.04W | 10x28mm    |                      |
| 15.12922  | 12V     |         | 2.2W  | 11x23mm    | Spherical shape      |
| ECA.1225  | 12V     | 250mA   | 3W    | 10x28mm    |                      |
| ECA.H1242 | 12V     |         | 5W    | 9.3x33mm   | Halogen              |
| 09.12905  | 12V     |         | 6W    | 15x28mm    | Vehicle light bulb   |
| 09.14080  | 14V     | 80mA    |       | 8.5x23mm   |                      |
| ECA.1810  | 18V     | 100mA   | 1.8W  | 10x28mm    |                      |
| ECA.2402  | 24V     | 20mA    | 480mW | 10x28mm    |                      |
| 09.24025  | 24V     | 25mA    |       | 8.5x23mm   |                      |
| 09.24050  | 24V     | 50mA    | 1.2W  | 8.5x23mm   |                      |
| ECA.2405  | 24V     | 50mA    | 1.2W  | 10x28mm    |                      |
| 09.24080  | 24V     | 80mA    |       | 8.5x23mm   |                      |
| ECA.2408  | 24V     | 80mA    | 1.92W | 10x28mm    |                      |
| 09.24920  | 24V     |         | 2W    | 8.5x23mm   | Vehicle light bulb   |
| 09.24930  | 24V     |         | 3W    | 8.5x23mm   | Vehicle light bulb   |
| ECA.2412  | 24V     | 125mA   | 3W    | 10x28mm    |                      |
| 10.28910  | 28V     |         | 1W    | 10x28mm    |                      |
| ECA.2805  | 28V     | 50mA    | 1.4W  | 10x28mm    |                      |
| 09.28920  | 28V     |         | 2W    | 8.5x23mm   |                      |
| 10.28920  | 28V     |         | 2W    | 10x28mm    |                      |
| ECA.2810  | 28V     | 107mA   | 3W    | 10x28mm    |                      |
| 09.30050  | 30V     | 50mA    | 1.5W  | 8.5x23mm   |                      |
| 09.30920  | 30V     |         | 2W    | 8.5x23mm   |                      |
| 09.30930  | 30V     |         | 3W    | 8.5x23mm   |                      |
| 10.30930  | 30V     |         | 3W    | 10x28mm    |                      |
| ECA.3602  | 36V     | 20mA    | 720mW | 10x28mm    |                      |
| ECA.3605  | 36V     | 50mA    | 1.8W  | 10x28mm    |                      |
| ECA.3608  | 36V     | 83mA    | 3W    | 10x28mm    |                      |
| ECA.4802  | 48V     | 20mA    | 960mW | 10x28mm    |                      |
| 10.48025  | 48V     | 25mA    | 1.2W  | 10x28mm    |                      |
| ECA.4804  | 48V     | 40mA    | 1.92W | 10x28mm    |                      |
| ECA.4806  | 48V     | 63mA    | 3W    | 10x28mm    |                      |
| ECA.6002  | 60V     | 20mA    | 1.2W  | 10x28mm    |                      |
| 10.60920  | 60V     |         | 2W    | 10x28mm    |                      |
| ECA.6004  | 60V     | 40mA    | 2.4W  | 10x28mm    |                      |
| 10.60930  | 60V     |         | 3W    | 10x28mm    |                      |
| 10.13015  | 130V    | 15mA    |       | 10x28mm    |                      |
| 09.13020  | 130V    | 20mA    |       | 8.5x23mm   |                      |
| 10.13020  | 130V    | 20mA    |       | 10x28mm    |                      |
| 10.13026  | 130V    |         | 2.6W  | 10x28mm    |                      |
| 09.22093  | 220V    |         | 3W    | 8.5x23mm   |                      |
| 10.24093  | 240V    |         | 3W    | 10x28mm    |                      |



**LED Lamps Ba9s (Miniature Bayonet Ba9s Socket)**

| Order No | Volt AC/DC | Current | Dimensions | Type      | Description     |
|----------|------------|---------|------------|-----------|-----------------|
| 85.8124A | 24V        |         | 10x25mm    | LD803A24A | 8 yellow LED    |
| 85.8224A | 24V        |         | 10x25mm    | LD803D24A | 8 yellow LED    |
| 85.8248A | 48V        |         | 10x25mm    | LD803D48A | 8 yellow LED    |
| 85.8224G | 24V        |         | 10x25mm    | LD803D24G | 8 green LED     |
| 85.8324A | 24V        |         | 11x20mm    | LD804A24A | 8 yellow LED    |
| 85.8124G | 24V        |         | 10x25mm    | LD803A24G | 8 green LED     |
| ELF.2420 | 24V        | 20mA    | 10x25mm    | W7B90     |                 |
| 85.8248G | 48V        |         | 10x25mm    | LD803D48G | 8 green LED     |
| 85.8424G | 24V        |         | 11x20mm    | LD804D24G | 8 green LED     |
| 85.8224M | 24V        |         | 10x25mm    | LD803D24M | 8 mixed colours |
| 85.8224R | 24V        |         | 10x25mm    | LD803D24R | 8 red LED       |
| 85.8248R | 48V        |         | 10x25mm    | LD803D48R | 8 red LED       |



ELF.2420



**Glow Lamps Ba9s (Miniature Bayonet Ba9s Socket)**

| Order No  | Voltage | Measure | Description                |
|-----------|---------|---------|----------------------------|
| ECA.G110  | 110V    | 10x28mm | With built-in pre-resistor |
| 70.09110  | 110V    | 10x25mm | Neon                       |
| 70.10116  | 110V    | 10x28mm | Neon                       |
| 70.10112  | 110V    | 10x28mm | Fluorescent red            |
| ECA.G220  | 220V    | 10x28mm | With built-in pre-resistor |
| 70.10225  | 220V    | 10x28mm | Fluorescent yellow         |
| ECA.G220G | 220V    | 10x28mm | For green lenses           |
| 70.10229  | 220V    | 10x28mm | Fluorescent green          |
| 70.10222  | 220V    | 10x28mm | Fluorescent rot            |
| 70.10224  | 220V    | 10x28mm | Fluorescent w white        |
| 70.10226  | 220V    | 10x28mm | Glass yellow colour        |
| ECA.G380  | 380V    | 10x28mm | With built-in pre-resistor |
| 70.09380  | 380V    | 10x25mm | Neon                       |

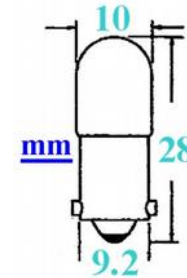

**Light Bulb Ba15d Socket (Double Contact Bayonet Ba15d)**

| Order No | Voltage   | Power | Dimensions | Description                    |
|----------|-----------|-------|------------|--------------------------------|
| 86.06916 | 6V        | 15W   | 16x52mm    | Vehicle light bulb             |
| 86.06915 | 6V        | 15W   | 18x53mm    | Vehicle light bulb             |
| 74.12950 | 12V       | 5W    | 16x54mm    |                                |
| 72.12911 | 12V       | 10W   | 18x37mm    | Spherical shape                |
| 83.12912 | 12V       | 12W   | 35x60mm    | Spherical shape                |
| 89.12593 | 12.5V     | 3A    | 35x58mm    | Mirrored (M)                   |
| 89.24925 | 24V       | 25W   | 39x63mm    | Dr G Fischer Vehicle light (M) |
| 89.24940 | 24V       | 40W   | 39x63mm    | Dr G Fischer Vehicle light (M) |
| 74.36910 | 36V       | 10W   | 26x54mm    |                                |
| 74.60950 | 60V       | 5W    | 16x54mm    |                                |
| 75.80950 | 80V       | 5W    | 16x48mm    |                                |
| 74.13047 | 110V-140V | 4-7W  | 22x43mm    |                                |
| 75.13071 | 110V-140V | 7-10W | 16x48mm    |                                |
| 63896    | 110V      | 15W   | 22x57mm    |                                |
| 89.11530 | 115V      | 30W   | 40x60mm    | Mirrored (M)                   |



Mirrored



Ba15d



**Glow Lamps Ba15d Socket (Double Contact Bayonet Ba15d)**

| Order No | Voltage | Measure | Description        |
|----------|---------|---------|--------------------|
| 70.74221 | 220V    | 16x52mm | Fluorescent yellow |
| 70.74222 | 220V    | 16x52mm | Fluorescent red    |
| 70.74220 | 220V    | 16x52mm | Neon               |
| 70.72380 | 380V    | 14x30mm | Neon               |



Ba15d

70.72380

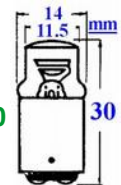

**Light Bulbs Ba15s Socket (Single Contact Bayonet Ba15s)**

| Order No  | Voltage | Power | Measure | Description                  |
|-----------|---------|-------|---------|------------------------------|
| 86.06910  | 6V      | 10W   | 13x34mm | Vehicle light bulb           |
| 72.06910S | 6V      | 10W   | 18x35mm | Hama 3569                    |
| 83.06910  | 6V      | 10W   | 25x42mm |                              |
| 86.62940  | 6.2V    | 40W   | 39x61mm | Mirrored (M)                 |
| 73.07063  | 7V      | 630mA | 18x35mm | Juke Box Bulb                |
| 86.12919  | 12V     | 18W   | 25x48mm | Vehicle light bulb           |
| 86.12921  | 12V     | 21W   | 26x52mm | Vehicle bulb OSRAM 7506 P21W |
| 83.12903  | 12.6V   | 3A    | 35x60mm |                              |
| 73.13059  | 13.5V   | 590mA | 18x35mm | Pin Ball Bulb                |
| 75.28921  | 28V     | 21W   | 16x52mm | Tapered                      |
| 89.28926  | 28V     | 26W   | 32x51mm | Mirrored (M)                 |
| 89.28940  | 28V     | 40W   | 39x61mm | Mirrored (M) 7079A           |
| 89.28941  | 28V     | 40W   | 32x61mm | Mirrored (M)                 |



Ba15s



Mirrored



**Light Bulbs Ba20d (Double Contact Bayonet Ba20d)**

| Order No | Voltage | Power | Dimensions | Description          |
|----------|---------|-------|------------|----------------------|
| 89.69500 | 6V      | 5A    | 35x60mm    | Colposcop OSRAM 8025 |
| 83.24940 | 24V     | 40W   | 45x70mm    |                      |
| 89.24950 | 24V     | 50W   | 42x67mm    | Mirrored (M)         |
|          |         |       |            |                      |
|          |         |       |            |                      |
|          |         |       |            |                      |



**Light Bulbs Ba20s (Single Contact Bayonet Ba20s)**

| Order No | Voltage | Power | Dimensions | Description             |
|----------|---------|-------|------------|-------------------------|
| 86.06935 | 6V      | 35W   | 35x60mm    | Vehicle lamp            |
| 86.12935 | 12V     | 35W   | 35x60mm    | Vehicle lamp OSRAM 7309 |

**T 3/4 Light Bulb MM3s6 Socket (MMF Micro Midget Flange)**

| Order No | Voltage | Current | Power | Schurter No |
|----------|---------|---------|-------|-------------|
| EBX.0104 | 1V      | 40mA    | 40mW  | 0913.0001   |
| EBX.0205 | 2V      | 50mA    | 100mW | 0913.0002   |
| EBX.0408 | 4V      | 50mA    | 200mW | 0913.0004   |
| 26.05021 | 5V      | 21mA    |       |             |
| EBX.0605 | 6V      | 50mA    | 300mW | 0913.0006   |
| EBX.1205 | 12V     | 50mA    | 600mW | 0913.0012   |
| 26.14030 | 14V     | 30mA    |       |             |
| EBX.1603 | 16V     | 30mA    | 480mW | 0913.0016   |
| EBX.2402 | 24V     | 20mA    | 480mW | 0913.0024   |
| 26.24040 | 24V     | 40mA    |       |             |
| 26.28020 | 28V     | 20mA    |       |             |

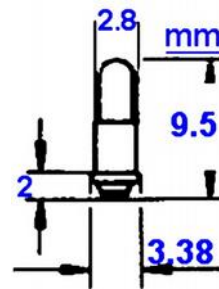

**ESY.x**  
Suitable lamp holders for light bulbs with T<sup>3/4</sup> MMF sockets  
**See page 23**

**T 3/4 Light Bulbs WT (Wire Terminal)**

| Order No | Voltage | Current | Power | Number   |
|----------|---------|---------|-------|----------|
| EAW.0101 | 1.5V    | 15mA    | 23mW  |          |
| EAW.0502 | 5V      | 20mA    | 100mW |          |
| EAW.0506 | 5V      | 60mA    | 300mW |          |
| 24.05075 | 5V      | 75mA    |       | 7133 USA |
| EAW.0511 | 5V      | 115mA   | 575mW |          |
| 24.24016 | 24V     | 16mA    |       |          |
| 24.28040 | 28V     | 40mA    |       |          |

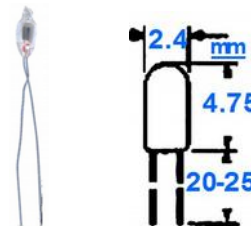

**T 1 Light Bulbs SX4s Socket (SMF Sub Midget Flange)**

| Order No | Voltage | Current | Number   |
|----------|---------|---------|----------|
| 30.05020 | 5V      | 30mA    |          |
| 30.05061 | 5V      | 60mA    | 685 USA  |
| 30.05115 | 5V      | 115mA   | 718 USA  |
| 30.06070 | 6V      | 70mA    |          |
| 30.06200 | 6V      | 200mA   |          |
| 30.10027 | 10V     | 27mA    | 7240 USA |
| 30.12030 | 12V     | 30mA    |          |
| 30.14065 | 14V     | 65mA    | 8112 USA |
| 30.18026 | 18V     | 26mA    | 7241 USA |
| 30.24020 | 24V     | 20mA    |          |
| 30.28024 | 28V     | 24mA    | 6839 USA |
| 30.28040 | 28V     | 40mA    |          |
| 30.36020 | 36V     | 20mA    |          |

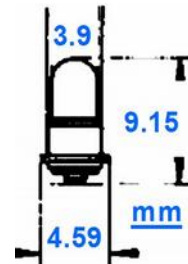

**T 1 Light Bulbs WT (Wire Terminal)**

| Order No | Voltage | Current | Power | Number            |
|----------|---------|---------|-------|-------------------|
| 29.03015 | 3V      | 15mA    |       | Bailey WE03030151 |
| EAX.0502 | 5V      | 20mA    | 100mW | 862WL USA         |
| 29.05030 | 5V      | 30mA    |       | Bailey WE03050301 |
| EAX.0506 | 5V      | 60mA    | 300mW | Bailey WE03050601 |
| 29.05075 | 5V      | 75mA    |       | Bailey WE03050751 |
| EAX.0511 | 5V      | 115mA   | 575mW | Bailey WE03051151 |
| EAX.1002 | 10V     | 27mA    | 270mW | Bailey WE03100271 |
| EAX.1203 | 12V     | 30mA    | 360mW | Bailey WE03120301 |
| EAX.1206 | 12V     | 60mA    | 720mW | Bailey WE03120601 |
| EAX.1404 | 14V     | 40mA    | 560mW | Bailey WE03140401 |
| EAX.1406 | 14V     | 65mA    | 910mW | Bailey WE03140651 |
| EAX.1802 | 18V     | 26mA    | 468mW | Bailey WE03180261 |
| EAX.2402 | 24V     | 20mA    | 480mW | Bailey WE03240201 |
| EAX.2802 | 28V     | 24mA    | 575mW | Bailey WE03280241 |
| 29.28040 | 28V     | 40mA    |       | Bailey WE03280401 |
| 29.750NE | 75VAC   | 200mA   | Neon  |                   |

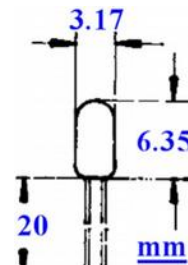



| T1 Light Bulbs BP Bi-Pin 1.27mm Pitch |         |         |                   |
|---------------------------------------|---------|---------|-------------------|
| Order No                              | Voltage | Current | Number            |
| 32.05061                              | 5V      | 60mA    | Bailey BP13050601 |
| 32.05075                              | 5V      | 75mA    | Bailey BP13050751 |
| 32.05115                              | 5V      | 115mA   | Bailey BP13051151 |
| 32.10027                              | 10V     | 27mA    | 8095 BP           |
| 32.12030                              | 12V     | 30mA    | Bailey BP13120301 |
| 32.12060                              | 12V     | 60mA    | Bailey BP13120601 |
| 32.18026                              | 18V     | 26mA    | 8099 BP           |
| 32.24020                              | 24V     | 20mA    |                   |
| 32.28024                              | 28V     | 24mA    | Bailey BP13280241 |
| 32.36020                              | 36V     | 20mA    |                   |

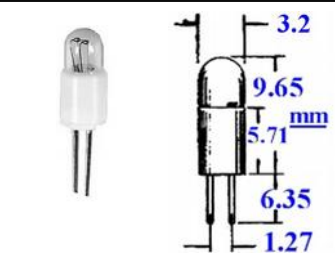

| T1 Light Bulbs BP Bi-Pin 2.54mm Pitch |         |         |                   |
|---------------------------------------|---------|---------|-------------------|
| Order No                              | Voltage | Current | Number            |
| 33.05020                              | 5V      | 20mA    |                   |
| 33.05060                              | 5V      | 60mA    | Bailey BP23050601 |
| EBP.0611                              | 6V      | 115mA   | Bailey BP23061151 |
| 33.12030                              | 12V     | 30mA    |                   |
| EBP.1206                              | 12V     | 60mA    | Bailey BP23120601 |
| EBP.1802                              | 18V     | 26mA    | Bailey BP23180261 |
| EBP.2402                              | 24V     | 24mA    | Bailey BP23240241 |
| EBP.2802                              | 28V     | 24mA    | Bailey BP23280241 |
| EBP.3602                              | 36V     | 20mA    | Bailey BP23360201 |

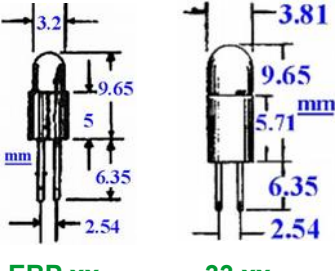

**ESP**  
Passende Lampenfassungen zu T1 BP 2.54mm Raster!  
**Siehe Seite 22**

| T1 Light Bulbs BP Bi-Pin 3.17mm Pitch |         |         |          |
|---------------------------------------|---------|---------|----------|
| Order No                              | Voltage | Current | Number   |
| 34.05075                              | 5V      | 75mA    |          |
| 34.05075                              | 10V     | 27mA    |          |
| 34.18026                              | 18V     | 26mA    |          |
| 34.24024                              | 24V     | 24mA    |          |
| 34.28024                              | 28V     | 24mA    | DE280120 |

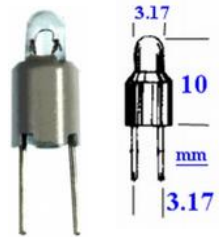

| T1 ¼ Light Bulbs SM5s/8 Socket (SMF) |         |         |             |
|--------------------------------------|---------|---------|-------------|
| Order No                             | Voltage | Current | Number      |
| 43.12050                             | 12V     | 50mA    | Alba A66233 |
| 43.14080                             | 14V     | 80mA    | 8646        |
| 43.16030                             | 16V     | 30mA    |             |
| 43.24020                             | 24V     | 20mA    |             |
| 43.24035                             | 24V     | 35mA    |             |
| 43.28040                             | 28V     |         |             |

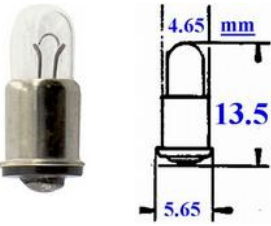

| T1 ¼ Light Bulbs BP Bi-Pin 2.54mm Pitch |         |         |                 |
|---|---------|---------|-----------------|
| Order No                                | Voltage | Current | Number          |
| 40.05060                                | 5V      | 60mA    |                 |
| 40.06060                                | 6V      | 60mA    |                 |
| 40.12040                                | 12V     | 40mA    | OL4032BPE       |
| 40.12060                                | 12V     | 60mA    |                 |
| 40.16030                                | 16V     | 30mA    | A-7588-3D       |
| 40.24035                                | 24V     | 35mA    |                 |
| 40.28024                                | 28V     | 24mA    | DH-2801         |
| 40.28040                                | 28V     | 40mA    | BQ243-50103A-LX |

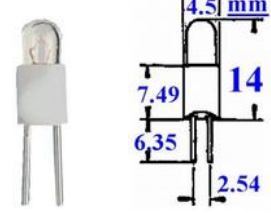

| T1 ¼ Light Bulbs BP Bi-Pin 3.17mm Pitch |         |         |           |
|---|---------|---------|-----------|
| Order No                                | Voltage | Current | Number    |
| 39.05060                                | 5V      | 60mA    |           |
| 39.12050                                | 12V     | 50mA    |           |
| 39.14081                                | 14V     | 80mA    | DI-140165 |
| 39.28040                                | 28V     | 40mA    | DI-280202 |

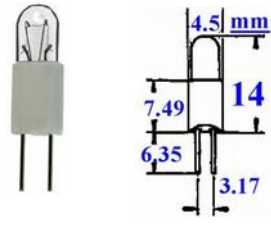

| T1 ¼ Light Bulbs WT (Wire Terminal) T3.8 |         |         |  |  |
|--|---------|---------|--|--|
| Order No                                 | Voltage | Current |  |  |
| 38.03530                                 | 3.5V    | 30mA    |  |  |
| 38.11020                                 | 11V     | 20mA    |  |  |
| 38.15020                                 | 15V     | 20mA    |  |  |
|  |         |         |  |  |
|  |         |         |  |  |

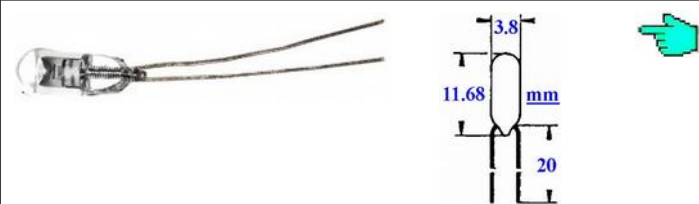

| T1 ¼ Light Bulbs WT (Wire Terminal) T4.2 |         |         |           |  |
|--|---------|---------|-----------|--|
| Order No                                 | Voltage | Current | Number    |  |
| 42.05060                                 | 5V      | 60mA    |           |  |
| 42.05115                                 | 5V      | 115mA   |           |  |
| 42.06030                                 | 6V      | 30mA    |           |  |
| 42.06060                                 | 6V      | 60mA    |           |  |
| 42.16030                                 | 16V     | 30mA    |           |  |
| 42.18040                                 | 18V     | 40mA    |           |  |
| 42.18041                                 | 18V     | 40mA    | AO-180160 |  |
| 42.24035                                 | 24V     | 35mA    |           |  |
| 42.24040                                 | 24V     | 40mA    |           |  |
| 42.28025                                 | 28V     | 25mA    |           |  |
| 42.28040                                 | 28V     | 40mA    |           |  |
| 42.60020                                 | 60V     | 20mA    |           |  |

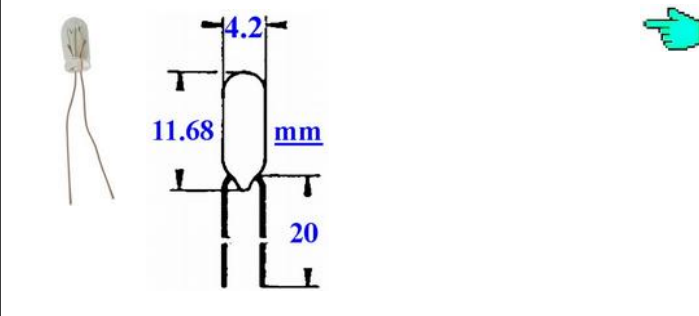

| T1 ¼ Light Bulbs Special Screw Base 4.78x13.5mm |         |         |               |  |
|---|---------|---------|---------------|--|
| Order No  | Voltage | Current | Number        |  |
| 36.13560  | 1.35V   | 60mA    | 8641 SS USA   |  |
| 36.03190  | 3V      | 190mA   | 325 USA       |  |
| 36.12050  | 12V     | 50mA    | (T4SS120050F) |  |
|   |         |         |               |  |
|   |         |         |               |  |

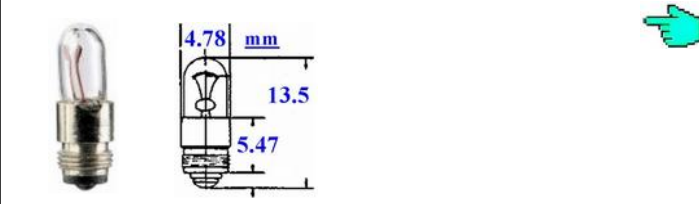

| T1 ¼ Light Bulbs Knurled Screw Base KSB |         |         |            |  |
|---|---------|---------|------------|--|
| Order No                                | Voltage | Current | Number     |  |
| 37.28040                                | 28V     | 40mA    | 8623KS USA |  |
|   |         |         |            |  |
|   |         |         |            |  |
|   |         |         |            |  |
|   |         |         |            |  |







| T1 ½ Light Bulbs Midget Screw E5 (E5/8) (LES Lilliput Edison Screw) |         |         |                  |  |
|---|---------|---------|------------------|--|
| Order No  | Voltage | Current | Number           |  |
| 44.25250  | 2.5V    | 250mA   | E5/8 LES         |  |
| 44.25300  | 2.5V    | 300mA   | E5/8 LES         |  |
| 44.25400  | 2.5V    | 400mA   | E5/8 LES         |  |
| 44.03015  | 3V      | 15mA    | E5/8 LES         |  |
| 44.03200  | 3.5V    | 200mA   | E5/8 LES         |  |
| 44.45200  | 4.5V    | 200mA   | E5/8 LES         |  |
| 44.06020  | 6V      | 20mA    | E5.5/16 (6x21mm) |  |
| 44.06100  | 6V      | 100mA   | E5/8 LES         |  |
| 44.12060  | 12V     | 60mA    | E5/8 LES         |  |
| 44.12120  | 12V     | 120mA   | E5.5/16 (6x21mm) |  |
| 44.14000  | 14V     | ??      | E5/8 LES         |  |
| 44.14040  | 14V     | 40mA    | E5/8 LES         |  |
| 44.24050  | 24V     | 50mA    | E5.5/16 (6x21mm) |  |
| 44.24060  | 24V     | 60mA    | E5/8 LES         |  |

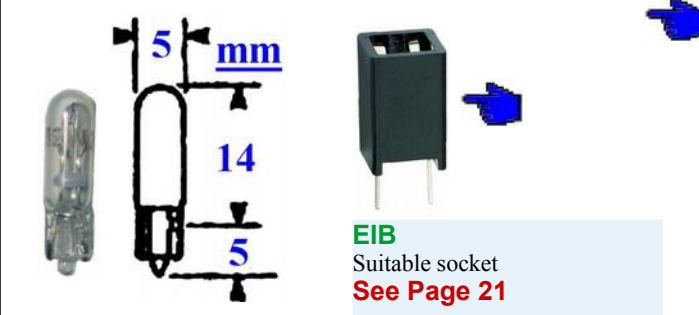

| T1 ½ Light Bulbs Midget Screw E5 (E5/8) (LES Lilliput Edison Screw) |         |         |       |            |
|---|---------|---------|-------|------------|
| Order No  | Voltage | Current | Power | Number     |
| ECC.0603  | 6V      | 30mA    | 180mW | Osram 2306 |
| ECC.0616  | 6V      | 166mA   | 1W    |            |
| ECC.1203  | 12V     | 30mA    | 360mW | Osram 2322 |
| ECC.1208  | 12V     | 83mA    | 1W    | Osram 2321 |
| ECC.2403  | 24V     | 30mA    | 720mW | Osram 2342 |
| ECC.2404  | 24V     |         | 1W    | Osram 2341 |
|   |         |         |       |            |
|   |         |         |       |            |
|   |         |         |       |            |
|   |         |         |       |            |

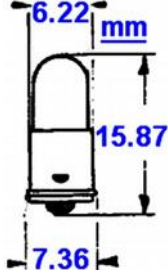

**EIB**  
Suitable socket  
**See Page 21**

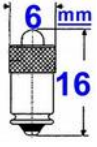
| T1 1/2   |           | Light Bulb with Cable                |                   |           |
|--|-----------|--------------------------------------|-------------------|-----------|
| Order No   | Voltage   | Current                              | Length Cable      |           |
| 35.06040   | 6V        | 40mA                                 | 255 mm            |           |
| 35.63040   | 6.3V      | 40mA                                 |                   |           |
| 35.12040   | 12V       | 40mA                                 |                   |           |
| 35.14040   | 14V       | 40mA                                 |                   |           |
| 35.24050   | 24V       | 50mA                                 |                   |           |
|    |           |                                      |                   |           |
| T1 1/2   |           | Light Bulbs WT (Wire Terminal) T5.1  |                   |           |
| Order No   | Voltage   | Current                              | Dimension         |           |
| 48.60050   | 60V       | 50mA                                 | 5.1 x 12mm        |           |
|    |           |                                      |                   |           |
| T1 3/4   |           | Light Bulb MF (Midget Flange) (SX6s) |                   |           |
| Order No   | Voltage   | Current                              | Number            | US Number |
| 64.02040   | 2V        | 40mA                                 |                   |           |
| 64.35200   | 3.5V      | 200mA                                |                   |           |
| 64.05060   | 5V        | 60mA                                 | Bailey MF06050602 | 7333 USA  |
| 64.05115   | 5V        | 115mA                                | Bailey MF06051151 | 7335 USA  |
| 64.06040   | 6V        | 40mA                                 | Bailey MF06060401 | 345 USA   |
| 64.06100   | 6V        | 100mA                                | Bailey MF06061001 |           |
| 64.63200   | 6.3V      | 200mA                                | Bailey MF06062002 | 381 USA   |
| 64.63265   | 6.3V      | 265mA                                |                   |           |
| 64.10014   | 10V       | 14mA                                 | Bailey MF06100151 | 344 USA   |
| 64.10040   | 10V       | 40mA                                 | Bailey MF06100401 | 367 USA   |
| 64.12040   | 12V       | 40mA                                 | Bailey MF06120401 | 394 USA   |
| 64.12100   | 12V       | 100mA                                | Bailey MF06121001 | 727 USA   |
| 64.18040   | 18V       | 40mA                                 | Bailey MF06180401 | 370 USA   |
| 64.24025   | 24V       | 25mA                                 | Bailey MF06240251 |           |
| 64.24050   | 24V       | 50mA                                 | Bailey MF06240501 |           |
| 64.24060   | 24V       | 60mA                                 | Bailey MF06240601 | 3226 USA  |
| 64.28025   | 28V       | 25mA                                 | Bailey MF06280251 | 721 USA   |
| 64.28030   | 28V       | 30mA                                 | Bailey MF06280301 |           |
| 64.28040   | 28V       | 40mA                                 | Bailey MF06280401 | 385 USA   |
| 64.28060   | 28V       | 60mA                                 | Bailey MF06280601 | 376 USA   |
| 64.28080   | 28V       | 80mA                                 | Bailey MF06280801 | 729 USA   |
| 64.32040   | 32V       | 40mA                                 |                   |           |
| 64.36020   | 36V       | 20mA                                 | Bailey MF06360201 | 730 USA   |
| 64.36030   | 36V       | 30mA                                 | Bailey MF06360301 |           |
| 64.48020   | 48V       | 20mA                                 | Bailey MF06480201 | 3248 USA  |
| 64.48025   | 48V       | 25mA                                 | Bailey MF06480251 | 6848 USA  |
| 64.48030   | 48V       | 30mA                                 | Bailey MF06480301 | 723 USA   |
| 64.60020   | 60V       | 20mA                                 | Bailey MF06600201 | 6195 USA  |
| 64.60030   | 60V       | 30mA                                 | Bailey MF06600301 | 734 USA   |
|   |           |                                      |                   |           |
|   |           |                                      |                   |           |
| T1 3/4   |           | Glow Lamp MF (Midget Flange) (SX6s)  |                   |           |
| Order No   | Voltage   | Description                          | Number            |           |
| 64.220NE   | 220V      | Neon                                 | ORNSC3 ORNSC-3    |           |
| T1 3/4   |           | LED Lamp MG (Midget Groove)          |                   |           |
| Order No   | Voltage   | Description                          |                   |           |
| EBM.LED.24G  | 24VAC/VDC | Green                                |                   |           |
|   |           |                                      |                   |           |
|  |           |                                      |                   |           |

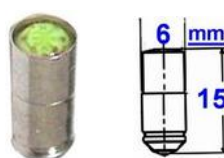
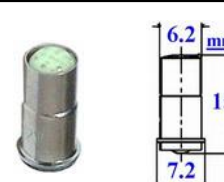
| T1 3/4 Light Bulb S5.7s (MG Midget Groove)         |         |                            |                   |  |
|--|---------|----------------------------|-------------------|--|
| Order No   | Voltage | Current                    | Number            | US Number  |
| 65.13560   | 1.35V   | 60mA                       | Bailey MG06010601 | 698 USA  |
| EBM.0235   | 2.5V    | 350mA                      | Bailey MG06023501 | 266 USA  |
| 65.27060   | 2.7V    | 60mA                       | Bailey MG06020601 | 8704 USA   |
| 65.05020   | 5V      | 20mA                       | Bailey MG06050201 | FG23 USA   |
| 65.05060   | 5V      | 60mA                       | Bailey MG06050601 | 7346 USA   |
| 65.05115   | 5V      | 115mA                      | Bailey MG06051151 | 7348 USA   |
| EBM.0610   | 6V      | 100mA                      | Bailey MG06061001 |  |
| EBM.0620   | 6V      | 200mA                      | Bailey MG06062001 | 337 USA  |
| EBM.0604   | 6V      | 40mA                       | Bailey MG06060401 | 8705 USA   |
| 65.63040   | 6.3V    | 40mA                       | Bailey MG06060402 | 7351 USA   |
| 65.63075   | 6.3V    | 75mA                       | Bailey MG06060751 | 8708 USA   |
| EBM.1004   | 10V     | 40mA                       | Bailey MG06100401 | 397 USA  |
| EBM.1204   | 12V     | 40mA                       | Bailey MG06120401 | 7354 USA   |
| EBM.1210   | 12V     | 100mA                      | Bailey MG06121001 |  |
| EBM.1402   | 14V     | 20mA                       | Bailey MG06140201 |  |
| EBM.1408   | 14V     | 80mA                       | Bailey MG06140801 | 386 USA  |
| EBM.1804   | 18V     | 40mA                       | Bailey MG06180401 | 346 USA  |
| 65.22040   | 22V     | 40mA                       | Bailey MG06220401 | 457 USA  |
| EBM.2402   | 24V     | 25mA                       | Bailey MG06240251 | 890 USA  |
| EBM.2405   | 24V     | 50mA                       | Bailey MG06240501 |  |
| 65.24060   | 24V     | 60mA                       | Bailey MG06240601 |  |
| EBM.2802   | 28V     | 25mA                       | Bailey MG06280251 | 719 USA  |
| 65.28030   | 28V     | 30mA                       | Bailey MG06280301 |  |
| EBM.2804   | 28V     | 40mA                       | Bailey MG06280401 | 7355 USA   |
| EBM.3603   | 36V     | 30mA                       | Bailey MG06360301 | 809 USA  |
| 65.48020   | 48V     | 20mA                       | Bailey MG06480201 | 805 USA  |
| EBM.4802   | 48V     | 25mA                       | Bailey MG06480251 | 2250 USA   |
| 65.48030   | 48V     | 30mA                       | Bailey MG06480302 | 796 USA  |
| EBM.6002   | 60V     | 20mA                       | Bailey MG06600201 | 6201 USA   |
| 65.60030   | 60V     | 30mA                       | Bailey MG06600301 | 735 USA  |
| T1 3/4 Glow Lamps S5.7s (MG Midget Groove)         |         |                            |                   |  |
| Order No   | Voltage | Description                | Number            |  |
| EBM.G90  | 90V     | Without dropping resistor  |                   |  |
| 65.110NE   | 120V    | Neon                       | Bailey NG16110GG  |  |
| EBM.G220   | 220V    | Built-in dropping resistor | Bailey NG16220GC  |  |
| T1 3/4 Light Bulbs E5.5 (MS Midget Screw)          |         |                            |                   |  |
| Order No   | Voltage | Current                    | Number            | US Number  |
| 67.25400   | 2.5V    | 400mA                      | Torch light bulb  |  |
| 67.06040   | 6V      | 40mA                       | Bailey MS06060401 | 342 USA  |
| 67.06060   | 6V      | 60mA                       | Bailey MS06060601 | 526 USA  |
| 67.06200   | 6V      | 200mA                      | Bailey MS06062001 | 1768 USA   |
| 67.14080   | 14V     | 80mA                       | Bailey MS06140801 | 8362 USA   |
| 67.18040   | 18V     | 40mA                       | Bailey MS06180401 | 8536 USA   |
| 67.24040   | 24V     | 40mA                       | Bailey MS06240401 | 686 USA  |
| 67.28040   | 28V     | 40mA                       | Bailey MS06280401 | 399 USA  |
| 67.28060   | 28V     | 60mA                       | Bailey MS06280601 |  |
| T1 3/4 Multi LED Lampen (MG Midget Groove S5.7s/8) |         |                            |                   |  |
| Order No   | Voltage | Description                | Type              |  |
| 86.1212R   | 12VDC   | Mit 6 roten LED            | LD0602D12R        |  |
| 86.1224A   | 24VDC   | Mit 6 gelben LED           | LD0602D24A        |  |
| 86.1224G   | 24VDC   | Mit 6 grünen LED           | LD0602D24G        |  |
| 86.1224R   | 24VDC   | Mit 6 roten LED            | LD0602D24R        |  |
| T1 3/4 Multi LED Lamps (MF Midget Flange SX6s)     |         |                            |                   |  |
| Order No   | Voltage | Description                | Type              |  |
| 86.1024A   | 24VDC   | Mit 6 gelben LED           | LD0601D24A        |  |
| 86.1024G   | 24VDC   | Mit 6 grünen LED           | LD0601D24G        |  |
| 86.1024R   | 24VDC   | Mit 6 roten LED            | LD0601D24R        |  |

**ESM.x + ESW.xx**  
Suitable lamp sockets for  
T1-3/4 MG

**See Page 22**





| <b>T1 3/4 Light Bulbs BP Bi-Pin 3.17mm Pitch</b> |         |         |                   |           |  |
|--|---------|---------|-------------------|-----------|--|
| Order No   | Voltage | Current | Number            | US Number |  |
| EBR.0235   | 2.5V    | 350mA   | Bailey BP36023501 | 7868 USA  |  |
| 66.05060   | 5V      | 60mA    |                   | 7360 USA  |  |
| EBR.0235   | 6V      | 40mA    | Bailey BP36060401 | 7945 USA  |  |
| EBR.0610   | 6V      | 100mA   |                   |           |  |
| EBR.0620   | 6V      | 200mA   | Bailey BP36062002 | 7328 USA  |  |
| 66.63040   | 6.3V    | 40mA    | Bailey BP36060402 | 7380 USA  |  |
| 66.63075   | 6.3V    | 75mA    | Bailey BP36060751 | 7377 USA  |  |
| 66.63200   | 6.3V    | 200mA   |                   | 7381 USA  |  |
| 66.10040   | 10V     | 40mA    | Bailey BP36100401 | 7367 USA  |  |
| EBR.1204   | 12V     | 40mA    | Bailey BP36120401 | 7371 USA  |  |
| EBR.1210   | 12V     | 100mA   |                   |           |  |
| EBR.1402   | 14V     | 20mA    |                   |           |  |
| EBR.1408   | 14V     | 80mA    | Bailey BP36140801 | 7382 USA  |  |
| EBR.1804   | 18V     | 40mA    | Bailey BP36180401 | 7370 USA  |  |
| EBR.2402   | 24V     | 25mA    |                   |           |  |
| EBR.2405   | 24V     | 50mA    | Bailey BP36240501 | 7001 USA  |  |
| EBR.2802   | 28V     | 25mA    |                   |           |  |
| EBR.2804   | 28V     | 40mA    | Bailey BP36280402 | 7327 USA  |  |
| 66.28080   | 28V     | 80mA    |                   |           |  |
| 66.30040   | 30V     | 40mA    |                   |           |  |
| EBR.3603   | 36V     | 30mA    |                   |           |  |
| 66.48020   | 48V     | 20mA    |                   |           |  |
| EBR.4802   | 48V     | 25mA    | Bailey BP36480251 | 7748 USA  |  |
| EBR.6002   | 60V     | 20mA    | Bailey BP36600201 | 7476 USA  |  |

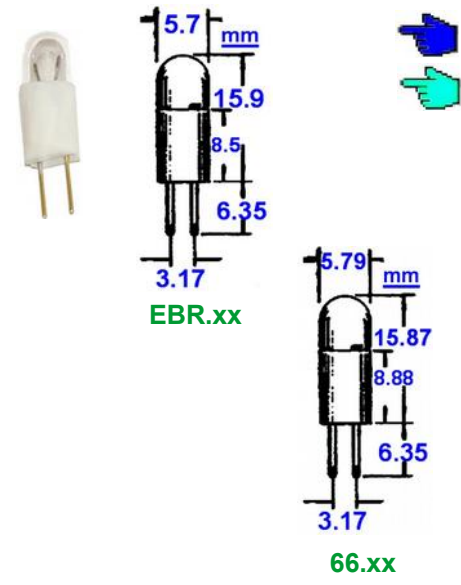

| <b>T1 3/4 Light Bulbs with Wedge Base (W2.1x9.5d)</b> |         |         |       |             |            |
|---|---------|---------|-------|-------------|------------|
| Order No  | Voltage | Current | Power | Bailey Type | US Number  |
| 52.06300  | 6V      | 300mA   |       |             | 2509       |
| ECD.0633  | 6V      | 333mA   | 2W    | WB28063331  | 2501       |
| 52.06920  | 6V      |         | 2W    | WB28063331  | 2501       |
| 52.06930  | 6V      |         | 3W    | WB28065001  |            |
| 52.06950  | 6V      |         | 5W    | WB28068301  |            |
| 52.63200  | 6.3V    | 200mA   |       |             |            |
| 52.63250  | 6.3V    | 250mA   |       | WB28062501  | 259        |
| 52.09270  | 9.6V    | 270mA   |       |             |            |
| ECD.1216  | 12V     | 166mA   | 2W    |             | Osram 2820 |
| 52.12930  | 12V     |         | 3W    | WB28122501  | 504        |
| 52.12950  | 12V     |         | 5W    | WB28124001  | 501        |
| 52.24910  | 24V     |         | 1W    |             |            |
| ECD.2408  | 24V     | 83mA    | 2W    | WB28240801  |            |
| 52.24930  | 24V     |         | 3W    | WB28241251  |            |
| 52.24940  | 24V     |         | 4W    | WB28241651  |            |
| 52.28040  | 28V     | 40mA    |       |             |            |
| 52.28060  | 28V     | 60mA    |       | WB28280601  | 656        |
| ECD.3605  | 36V     | 56mA    | 2W    |             |            |
| ECD.4804  | 48V     | 42mA    | 2W    |             |            |

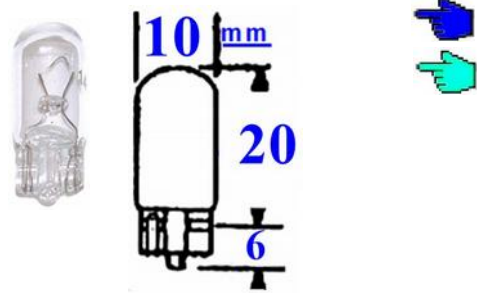

| <b>T1 3/4 Light Bulbs WT Wire Terminal</b> |         |         |        |            |      |
|--|---------|---------|--------|------------|------|
| Order No                                   | Voltage | Current | Number | US Number  |      |
| EAZ.0235                                   | 2.5V    | 350mA   | 875mW  | WE06023501 |      |
| 63.05015                                   | 5V      | 15mA    |        | WE06050151 |      |
| 63.05060                                   | 5V      | 60mA    |        | WE06050601 | 2200 |
| 63.05115                                   | 5V      | 115mA   |        |            |      |
| EAZ.0604                                   | 6V      | 40mA    | 240mW  | WE06060401 | 1730 |
| EAZ.0610                                   | 6V      | 100mA   | 600mW  | WE06061001 | 714  |
| EAZ.0620                                   | 6V      | 200mA   | 1.2W   | WE06062001 | 1784 |
| 63.63200                                   | 6.3V    | 200mA   |        | WE06062002 | 2181 |
| EAZ.1204                                   | 12V     | 40mA    | 480mW  | WE06120401 | 2174 |
| EAZ.1206                                   | 12V     | 60mA    | 720mW  | WE06120601 |      |
| EAZ.1220                                   | 12V     | 120mA   | 1.44W  |            |      |
| EAZ.1402                                   | 14V     | 20mA    | 280mW  |            |      |
| EAZ.1408                                   | 14V     | 80mA    | 1.12W  | WE06140801 | 2182 |
| EAZ.1804                                   | 18V     | 40mA    | 720mW  | WE06180401 | 2102 |
| EAZ.2405                                   | 24V     | 50mA    | 1.2W   | WE06240501 | 2176 |
| EAZ.2804                                   | 28V     | 40mA    | 1.12W  | WE06280401 | 2185 |
| 63.32040                                   | 32V     | 40mA    |        |            |      |
| EAZ.3603                                   | 36V     | 30mA    | 1.08W  |            |      |
| 63.48020                                   | 48V     | 20mA    |        | WE06480201 | FW48 |
| EAZ.4802                                   | 48V     | 25mA    | 1.2W   |            |      |
| 63.48030                                   | 48V     | 30mA    |        |            |      |
| EAZ.6002                                   | 60V     | 20mA    | 1.2W   | WE06600201 | FW60 |

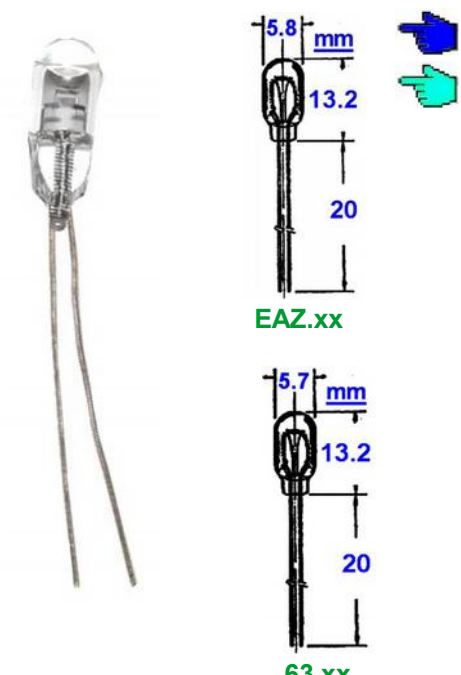

| <b>T1 3/4 Glow Lamp WT Wire Terminal</b> |         |         |        |           |      |
|--|---------|---------|--------|-----------|------|
| Order No                                 | Voltage | Current | Number | US Number |      |
| 70.84001                                 | 90V     |         |        |           | NP2L |

| Glow Lamps WT Wire Terminal |         |                  |  |
|-----------------------------|---------|------------------|--|
| Order No                    | Voltage | Description      |  |
| ENE.2                       | 55-67V  | Without resistor |  |
| ENE.2F                      | 95V     | Without resistor |  |
| ENE.2R                      | 220V    | With resistor    |  |
|                             |         |                  |  |
|                             |         |                  |  |
|                             |         |                  |  |

| Light Bulbs SX3 Special Midget Flange |         |         |        |
|---------------------------------------|---------|---------|--------|
| Order No                              | Voltage | Current | Length |
| 27.05115                              | 5V      | 115mA   | 9.1mm  |
| 27.05000                              | 5V      |         | 11.4mm |
| 27.12060.SMF                          | 12V     | 60mA    | 8mm    |
| 27.12060.LMF                          | 12V     |         | 7.9mm  |

| T5 Light Bulbs with Wedge Base (W2x4.6d) |         |         |             |           |
|--|---------|---------|-------------|-----------|
| Order No                                 | Voltage | Current | Bailey Type | US Number |
| 50.01510                                 | 1.5V    | 100mA   |             |           |
| 50.03035                                 | 3V      | 35mA    |             |           |
| 50.03350                                 | 3V      | 350mA   |             |           |
| 51.63200                                 | 6.3V    | 200mA   |             |           |
| 50.09040                                 | 9V      | 40mA    |             |           |
| 50.12912                                 | 12V     | 1.2W    | WB20121001  | 2122      |
| 50.12920                                 | 12V     | 2W      | WB20121651  | 2123      |
| 51.14040                                 | 14V     | 40mA    |             | 18        |
| 51.14080                                 | 14V     | 80mA    | WB20140801  | 73        |
| 50.14914                                 | 14V     | 1.4W    | WB20141001  | 74        |
| 50.24912                                 | 24V     | 1.2W    | WB20240501  |           |
| 51.28040                                 | 28V     | 40mA    | WB20280401  | 85        |
| 51.60020                                 | 60V     | 20mA    | WR20600201  | 86        |

| T15 Light Bulbs with Wedge Base (W2x4.6d) |         |         |             |           |
|---|---------|---------|-------------|-----------|
| Order No                                  | Voltage | Current | Bailey Type | US Number |
| 53.12069                                  | 12.8V   | 690mA   | WB35130690  | 906       |
| 53.1281A                                  | 12.8V   | 1A      | WB35121000  | 912       |

| Light Bulbs for Light Strings |         |       |  |  |
|-------------------------------|---------|-------|--|--|
| Order No                      | Voltage | Power |  |  |
| ECL.1208                      | 12V     | 1W    |  |  |
| ECL.2404                      | 24V     | 1W    |  |  |
|                               |         |       |  |  |
|                               |         |       |  |  |
| Suitable Light String         |         |       |  |  |
| KLK.10.9                      |         |       |  |  |

| <b>Light Bulbs with Fast-On Receptacle 6.3 x 0.8mm</b> |             |                   |                              |                        |  |
|--|-------------|-------------------|------------------------------|------------------------|--|
| Order No   | Voltage     | Power             |                              |                        |  |
| ESD.L6   | 6V          | 1W                |                              |                        |  |
| ESD.L12  | 12V         | 1W                |                              |                        |  |
| ESD.L24  | 24V         | 1W                |                              |                        |  |
| <b>Glow Lamps with Fast-On Receptacle 6.3 x 0.8mm</b>  |             |                   |                              |                        |  |
| Order No   | Voltage     | Power             |                              |                        |  |
| ESD.L220   | 230V        | 0.5W              | Neon                         |                        |  |
| ESD.L220.5   | 230V        | 0.5W              | Fluorescent for green lenses |                        |  |
| ESD.L380   | 380V        |                   | Neon                         |                        |  |
|  |             |                   |                              |                        |  |
|  |             |                   |                              |                        |  |
| <b>Multi LED Lamps M10F (13 x 44mm)</b>                |             |                   |                              |                        |  |
| Order No   | Voltage     | Power             |                              |                        |  |
| 85.9824G   | 24VDC       | With 8 green LED  |                              |                        |  |
| 85.9824A   | 24VDC       | With 8 yellow LED |                              |                        |  |
| 85.9824R   | 24VDC       | With 8 red LED    |                              |                        |  |
|  |             |                   |                              |                        |  |
|  |             |                   |                              |                        |  |
| <b>LED Lamps with GU5.3 Socket 51x51mm</b>             |             |                   |                              |                        |  |
| Order No   | Voltage     | Colour            | Angle                        | Power                  |  |
| LED.6-24KW3W25   | 6-24V       | pure w hite       | 25°                          | 3W                     |  |
| LED.6-24KW3W100  | 6-24V       | pure w hite       | 100°                         | 3W                     |  |
| LED.6-24WW3W25   | 6-24V       | w arm w hite      | 25°                          | 3W                     |  |
| LED.6-24WW3W100  | 6-24V       | w arm w hite      | 100°                         | 3W                     |  |
|  |             |                   |                              |                        |  |
|  |             |                   |                              |                        |  |
| <b>LED Spot Cree with MR16 Socket</b>                  |             |                   |                              |                        |  |
| Order No   | Voltage     | Angle             | Colour                       |                        |  |
| LED.11-18-3WW  | 11-18VAC/DC | 38°               | w arm w hite                 |                        |  |
| LED.11-18-6WW  | 11-18VAC/DC | 38°               | w arm w hite                 |                        |  |
|  |             |                   |                              |                        |  |
|  |             |                   |                              |                        |  |
| <b>Projection Lamps</b>                                |             |                   |                              |                        |  |
| Order No   | Voltage     | Power             | Measure                      | Socket (Type)          |  |
| 89.06500   | 6V          | 5A                | 19x58mm                      | SX15s (Philips 6103)   |  |
| 89.24150   | 24V         | 150W              | 32x97mm                      | Gy17q FUJI CYN         |  |
| 87.11975   | 110V        | 750W              | 38x141mm                     | P28 (Seiko SP-12 SP12) |  |
| 87.11910   | 110V        | 1000W             | 38x141mm                     | P28 (Seiko SP-12 SP12) |  |
| 89.11150   | 110-120V    | 150W              | 26x90mm                      | Ba15s CEW/CFC          |  |
| 89.12400   | 120V        | 400W              | 27x100mm                     | Ba15s T8-½-C13D (BEM)  |  |
| 87.22976   | 220V        | 750W              | 38x141mm                     | P28 (Seiko S-12 SP12)  |  |
| 87.22910   | 220V        | 1000W             | 38x141mm                     | P28 (Seiko S-12 SP12)  |  |
| 89.22500   | 220V-250V   | 500W              | 40x210mm                     | E40                    |  |

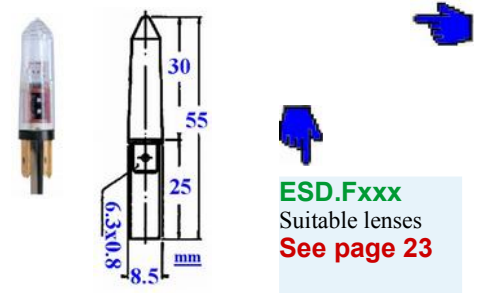

**ESD.Fxxx**  
Suitable lenses  
**See page 23**



**Halogen Light Bulbs Low Voltage with G4 Socket**

| Order No    | Voltage | Power | Measure | Type              |
|-------------|---------|-------|---------|-------------------|
| 87.06920    | 6V      | 20W   | 9x29mm  | JC FHE            |
| HG4.006.035 | 6V      | 35W   | 8x30mm  | Bailey HG4006035F |
| 87.12910    | 12V     | 10W   | 9x31mm  |                   |
| HG4.012.010 | 12V     | 10W   | 8x30mm  | Bailey HG4012010  |
| HG4.012.020 | 12V     | 20W   | 8x30mm  | Bailey HG4012020  |
| HG4.024.020 | 24V     | 20W   | 8x30mm  | Bailey HG4024020  |



**Halogen Light Bulb with GY Socket**

| Order No     | Voltage | Power | Measure | Socket | Type          |
|--------------|---------|-------|---------|--------|---------------|
| 87.06935     | 6V      | 35W   | 12x44mm | GY6.35 | Philips 13094 |
| 87.12935     | 12V     | 35W   | 12x44mm | GY6.35 | Osram 64432   |
| 87.12951     | 12V     | 50W   | 10x38mm | GY6.35 | Osram 64440   |
| 87.12950     | 12V     | 50W   | 12x44mm | GY6.35 | Philips 13079 |
| 87.12975     | 12V     | 75W   |         | GY6.35 | Osram 64450   |
| 87.23950     | 22.8V   | 50W   | 11x41mm | GY6.35 | BT018566      |
| 87.24950     | 24V     | 50W   | 11x43mm | GY6.35 | Osram 64445   |
| 87.24951     | 24V     |       | 11x45mm | GY9.5  | H24501        |
| HY6.024.250X | 24V     | 250W  | 15x54mm | GY6.35 | HY6024250X    |
| HY6.240.150  | 240V    | 150W  | 14x54mm | GY6.35 | HY6240150     |



**Halogen Light Bulb with GX Socket**

| Order No | Voltage | Power | Measure   | Socket      | Type          |
|----------|---------|-------|-----------|-------------|---------------|
| 87.12952 | 12V     | 50W   | 50x50mm   | GX5.3/GU5.3 | EXN (22314)   |
| 87.20150 | 20V     | 150W  | 50x43mm   | GX5.3 DDL   | Philips 13094 |
| 87.36934 | 36V     | 340W  | 50x47mm   | GX5.3 DDL   | ERV (H24501)  |
| 87.23910 | 230V    | 1000W | 24x67.5mm | G6.35-25    | Osram 64575   |



**Halogen Light Bulb with GZ Socket**

| Order No  | Voltage | Power | Measure | Socket | Type |
|-----------|---------|-------|---------|--------|------|
| HLX.64627 | 12V     | 100W  | 42x50mm | GZ6.35 |      |



**Halogen Light Bulb with Rafi F9 Socket**

| Order No | Voltage | Power | Measure | Socket  | Type   |
|----------|---------|-------|---------|---------|--------|
| 57.12120 | 12V     | 120mA | 9x28mm  | Rafi F9 | 901212 |
|          |         |       |         |         |        |
|          |         |       |         |         |        |
|          |         |       |         |         |        |
|          |         |       |         |         |        |



**Halogen Lamps with R7s Socket**

| Order No | Voltage | Power | Measure    | Type              |
|----------|---------|-------|------------|-------------------|
| 87.22975 | 22.8V   | 75W   | 10x63mm    |                   |
| 87.22250 | 240V    | 250W  | 11x117.6mm |                   |
| 87.22302 | 230V    | 300W  | 10x117mm   |                   |
| 87.22300 | 230V    | 300W  | 11x117.6mm | Philips 300T3Q/CL |
| 87.22301 | 240V    | 300W  | 11x117.6mm |                   |
| 87.22501 | 230V    | 500W  | 10x117mm   |                   |
| 87.22750 | 230V    | 750W  | 11x189mm   |                   |
| 87.21000 | 230V    | 1000W | 11x189mm   |                   |



**Fluorescent Lamps**

| Order No | Voltage | Power | Measure  | Type    |
|----------|---------|-------|----------|---------|
| 84.22906 | 220V    | 6W    | 16x212mm | TL6W/33 |
| 84.22908 | 220V    | 8W    | 16x288mm | TL8W/96 |
|          |         |       |          |         |



**Microscope Lamp with Bajonet Socket for grey and black Zeiss Microscope**

| Order No | Voltage | Power | Measure | Description                |
|----------|---------|-------|---------|----------------------------|
| 89.06915 | 6V      | 15W   | 13x52mm | Carl Zeiss 380177 38-01-77 |
|          |         |       |         |                            |
|          |         |       |         |                            |
|          |         |       |         |                            |
|          |         |       |         |                            |





**Fuse Type Pilot Lamp SF 6.3x30mm**

| Order No | Volta | Current | Power | Bailey Type |
|----------|-------|---------|-------|-------------|
| ECF.0610 | 6V    | 100mA   | 600mW | SF3106100   |
| ECF.0620 | 6V    | 200mA   | 1.2W  | SF3106200   |
| ECF.0630 | 6V    | 300mA   | 1.8W  | SF3106300   |
| ECF.0810 | 8V    | 100mA   | 800mW | SF3108100   |
| ECF.0820 | 8V    | 200mA   | 1.6W  | (SF3108250) |
| ECF.0830 | 8V    | 300mA   | 2.4W  | SF3108300   |
| ECF.1206 | 12V   | 60mA    | 720mW |             |
| ECF.1210 | 12V   | 100mA   | 1.2W  | SF3112100   |
| ECF.1408 | 14V   | 80mA    | 1.12W |             |
| ECF.1415 | 14V   | 150mA   | 2.1W  |             |
| ECF.2408 | 24V   | 80mA    | 1.92W |             |



**Festoon Light Bulb**

| Order No  | Volta | Current | d    | L          | Bailey Type |
|-----------|-------|---------|------|------------|-------------|
| 90.11203  | 12V   | 3W      | 6mm  | 31mm       | S63112250   |
| 90.12403  | 24V   | 3W      |      | S63124125  |             |
| 90.61203  | 12V   | 3W      | 6mm  | 36mm       | S63612003   |
| 90.61225  | 12V   | 3W      |      | S63612003  |             |
| 90.81203  | 12V   | 3W      | 6mm  | 38mm       | ~S63912003  |
| 90.82403  | 24V   | 3W      |      | ~S63924003 |             |
| 91.81202  | 12V   | 2W      | 8mm  | 29mm       | ~S72812002  |
| 91.82405  | 24V   | 5W      |      | ~S72824005 |             |
| 91.10603  | 6V    | 3W      | 8mm  | 31mm       | S73106003   |
| 91.13203  | 32V   | 3W      |      | S73132003  |             |
| 91.90603  | 6V    | 3W      | 8mm  | 38mm       | ~S73906003  |
| 91.91203  | 12V   | 3W      |      |            | ~S73912003  |
| 91.92403  | 24V   | 3W      |      |            | ~S73924003  |
| 92.924002 | 24V   | 2W      | 11mm | 38mm       | ~S83924002  |
| 92.91210  | 12V   | 10W     | 11mm | 39mm       | S83912010   |
| 92.93005  | 30V   | 5W      |      |            | S83930005   |
| 92.40603  | 6V    | 3W      | 11mm | 44mm       | S84406003   |
| 92.42403  | 24V   | 3W      |      |            | S84424003G  |
| 93.12905  | 12V   | 5W      | 15mm | 44mm       | S84512005   |
| 93.12910  | 12V   | 10W     |      |            | S84512010   |
| 93.24910  | 24V   | 10W     |      |            | S84524010   |
| 93.28905  | 28V   | 5W      |      |            |             |
| 93.60905  | 60V   | 5W      |      |            | S84560005   |



92.42403



**T4.5 Telecommunication Lamp (4.5 x 16.5mm) with Socket T4.5**

| Order No  | Voltage | Current |      | Bailey Type |
|-----------|---------|---------|------|-------------|
| 45.06050  | 6V      | 50mA    |      | T4506050    |
| 45.06070  | 6V      | 70mA    |      | T4506070    |
| 45.12020  | 12V     | 20mA    |      | T4512020    |
| 45.12040  | 12V     | 40mA    |      | T4512040    |
| 45.16060  | 16V     | 60mA    |      |             |
| 45.24020  | 24V     | 20mA    |      | T4524020    |
| EBU.2405K | 24V     | 50mA    |      | T4524050    |
| 45.30020  | 30V     | 20mA    |      | T4530020    |
| 45.30040  | 30V     | 40mA    |      | T4530040    |
| 45.36020  | 36V     | 20mA    |      | T4536020    |
| 45.60020  | 60V     | 20mA    |      | T4560020    |
| 45.110NE  | 110V    | 1.5A    | Neon |             |

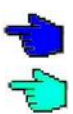

| <b>T4.6 Telecommunication Light Bulbs (4.6 x 22mm) with Socket T4.6</b> |         |         |            |             |
|---|---------|---------|------------|-------------|
| Order No  | Voltage | Current | Power      | Bailey Type |
| EBU.0602  | 6V      | 20mA    | 120mW      | T4606020    |
| 46.06040  | 6V      | 40mA    |            | T4606040    |
| EBU.0605  | 6V      | 50mA    | 300mW      | T4606050    |
| EBU.0610  | 6V      | 100mA   |            | T4606100    |
| EBU.0620  | 6V      | 200mA   | 1.2W       | T4606200    |
| EBU.1202  | 12V     | 20mA    | 240mW      | T4612020    |
| EBU.1204  | 12V     | 40mA    | 480mW      | T4612040    |
| 46.12050  | 12V     | 50mA    |            | T4612050    |
| 46.12080  | 12V     | 80mA    |            |             |
| 46.12100  | 12V     | 100mA   |            | T4612100    |
| EBU.1802  | 18V     | 25mA    | 450mW      | T4618025    |
| EBU.2402  | 24V     | 20mA    | 480mW      | T4624020    |
| 46.24030  | 24V     | 30mA    |            | T4624030    |
| EBU.2405  | 24V     | 50mA    | 1.2W       | T4624050    |
| 46.28020  | 28V     | 20mA    |            | T4628020    |
| 46.28040  | 28V     | 40mA    |            | T4628040    |
| 46.28050  | 28V     | 50mA    |            |             |
| 46.30020  | 30V     | 20mA    |            | T4630020    |
| 46.30040  | 30V     | 40mA    |            | T4630040    |
| 46.30050  | 30V     | 50mA    |            |             |
| EBU.3602  | 36V     | 20mA    | 720mW      | T4636020    |
| EBU.4802  | 48V     | 20mA    | 960mW      | T4648020    |
| EBU.6002  | 60V     | 20mA    | 1.2W       | T4660020    |
| 46.70020  | 70V     | 20mA    |            | T4670020    |
| 46.220NE  | 220V    | 500mA   | Glimm Neon |             |

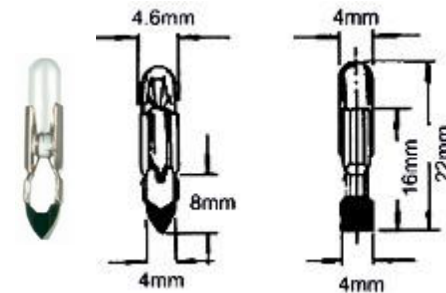

**ESU.x**  
Suitable fittings for  
T4.6 light bulbs  
**See Page 22**



| <b>T5.5K Telecommunication Light Bulbs (5.4 x 22mm) with Socket T5.5K</b> |         |         |       |             |
|---|---------|---------|-------|-------------|
| Order No  | Voltage | Current | Power | Bailey Type |
| 54.06100  | 6V      | 100mA   |       | T5606100    |
| 54.06200  | 6V      | 200mA   |       | T5606200    |
| 54.12020  | 12V     | 20mA    |       | T5612020    |
| EBW.1204K   | 12V     | 40mA    |       | T5612040    |
| 54.12040  | 12V     | 40mA    |       | T5612040    |
| 54.12100  | 12V     | 100mA   |       | T5612100    |
| 54.24020  | 24V     | 20mA    |       | T5624020    |
| 54.24025  | 24V     | 25mA    |       |             |
| 54.24030  | 24V     | 30mA    |       | T5624030    |
| 54.24040  | 24V     | 40mA    |       | T5624040    |
| 54.24050  | 24V     | 50mA    |       | T5624050    |
| 54.28040  | 28V     | 40mA    |       | T5628040    |
| 54.28050  | 28V     | 50mA    |       | T5628050    |
| 54.30020  | 30V     | 20mA    |       | T5630020    |
| 54.30040  | 30V     | 40mA    |       | T5630040    |
| 54.36020  | 36V     | 20mA    |       | T5636020    |
| 54.48020  | 48V     | 20mA    |       | T5648020    |
| 54.60020  | 60V     | 20mA    |       | T5660020    |
| 54.110NE  | 110V    | 1.5A    | Neon  |             |



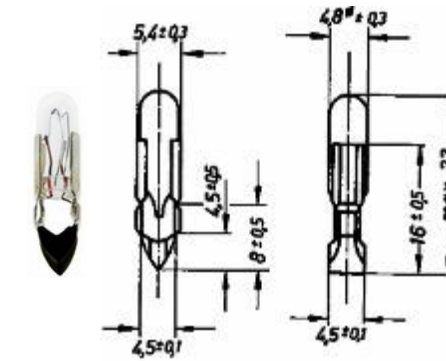

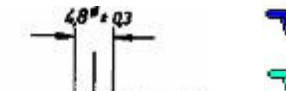

| <b>T5.5 Multi LED (54 x 30mm) with Socket T5.5</b> |         |                        |
|--|---------|------------------------|
| Order No   | Voltage | Description            |
| 86.2124A   | 24VDC   | With 4 yellow Chip LED |
| 86.2124G   | 24VDC   | With 4 green Chip LED  |
| 86.2124R   | 24VDC   | With 4 red Chip LED    |
|  |         |                        |
|  |         |                        |
|  |         |                        |
|  |         |                        |





| <b>T5.5 Telecommunication Light Bulbs (5.4 x 30mm) with Socket T5.5</b> |         |         |                                       |             |
|---|---------|---------|---------------------------------------|-------------|
| Order No  | Voltage | Current | Power                                 | Bailey Type |
| EBW.0602  | 6V      | 20mA    | 120mW                                 | T5506020    |
| 55.06040  | 6V      | 40mA    |                                       | T5506040    |
| EBW.0605  | 6V      | 50mA    | 300mW                                 | T5506050    |
| EBW.0610  | 6V      | 100mA   | 600mW                                 | T5506100    |
| EBW.0620  | 6V      | 200mA   | 1.2W                                  | T5506200    |
| EBW.1202  | 12V     | 20mA    | 240mW                                 | T5512020    |
| 55.12040  | 12V     | 40mA    |                                       | T5512040    |
| EBW.1205  | 12V     | 50mA    | 600mW                                 | T5512050    |
| 55.12080  | 12V     | 80mA    |                                       | T5512080    |
| EBW.1210  | 12V     | 100mA   | 1.2W                                  | T5512100    |
| EBW.1802  | 18V     | 25mA    | 450mW                                 | T5518025    |
| EBW.2402  | 24V     | 20mA    | 480mW                                 | T5524020    |
| 55.24030  | 24V     | 30mA    |                                       | T5524030    |
| 55.24040  | 24V     | 40mA    |                                       | T5524040    |
| EBW.2405  | 24V     | 50mA    | 1.2W                                  | T5524050    |
| EBW.2802  | 28V     | 20mA    | 560mW                                 | T5528020    |
| EBW.2804  | 28V     | 40mA    |                                       | T5528040    |
| EBW.2805  | 28V     | 50mA    | 1.4W                                  | T5528050    |
| 55.30020  | 30V     | 20mA    |                                       | T5530020    |
| 55.30040  | 30V     | 40mA    |                                       | T5530040    |
| 55.30050  | 30V     | 50mA    |                                       | T5530050    |
| EBW.3602  | 36V     | 20mA    | 720mW                                 | T5536020    |
| EBW.3603  | 36V     | 35mA    | 1.26W                                 | T5536030    |
| 55.36040  | 36V     | 40mA    |                                       | T5536040    |
| 55.36050  | 36V     | 50mA    |                                       | T5536050    |
| 55.42020  | 42V     | 20mA    |                                       |             |
| EBW.4802  | 48V     | 25mA    | 1.2W                                  | T5548025    |
| 55.48030  | 48V     | 30mA    |                                       | T5548030    |
| 55.48040  | 48V     | 40mA    |                                       |             |
| 55.55020  | 55V     | 20mA    |                                       |             |
| EBW.6002  | 60V     | 20mA    | 1.2W                                  | T5560020    |
| 55.60030  | 60V     | 30mA    |                                       | T5560030    |
| 55.70020  | 70V     | 20mA    |                                       | T5570020    |
| 55.110GF  | 110V    | 1.5A    | Fluorescent w ith integrated resistor |             |
| EBW.G110  | 110V    | 1.5A    | Glow lamp w ith built in resistor     |             |
| EBW.G220  | 220V    | 1.5A    | Glow lamp w ith built in resistor     |             |
| EBW.G220G   | 220V    | 1.5A    | Fluorescent lamp                      |             |

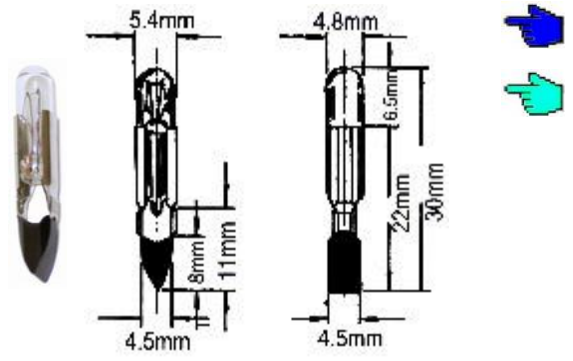

| <b>T6.8 Telecommunication Light Bulb (6.8 x 46.5mm) with Socket T6.8</b> |         |         |       |                                      |
|--|---------|---------|-------|--------------------------------------|
| Order No   | Voltage | Current | Power | Bailey Type                          |
| 68.06020   | 6V      | 20mA    |       | T6806020                             |
| 68.06040   | 6V      | 40mA    |       | T6806040                             |
| 68.06050   | 6V      | 50mA    |       | T6806050                             |
| EBT.0610   | 6V      | 100mA   | 600mW | T6806100                             |
| 68.06100   | 6V      | 100mA   |       | T6806100                             |
| EBT.0620   | 6V      | 200mA   | 1.2W  | T6806200                             |
| EBT.1202   | 12V     | 20mA    | 240mW | T6812020                             |
| EBT.1204   | 12V     | 40mA    |       | T6812040                             |
| EBT.1205   | 12V     | 50mA    | 600mW | T6812050                             |
| EBT.1210   | 12V     | 100mA   | 1.2W  | T6812100                             |
| 68.12120   | 12V     | 120mA   |       | T6812120                             |
| EBT.2402   | 24V     | 20mA    | 480mW | T6824020                             |
| 68.24040   | 24V     | 40mA    |       | T6824040                             |
| EBT.2405   | 24V     | 50mA    | 1.2W  | T6824050                             |
| 68.24080   | 24V     | 80mA    |       | T6824080                             |
| EBT.2804   | 28V     | 40mA    | 1.26W | T6828040                             |
| 68.30020   | 30V     | 20mA    |       | T6830020                             |
| EBT.3004   | 30V     | 40mA    |       | T6830040                             |
| 68.30050   | 30V     | 50mA    |       | T6830050                             |
| EBT.3602   | 36V     | 20mA    | 720mW | T6836020                             |
| EBT.3603   | 36V     | 35mA    | 1.26W | T6836035                             |
| 68.36040   | 36V     | 40mA    |       | T6836040                             |
| 68.36050   | 36V     | 50mA    |       | T6836050                             |
| 68.42020   | 42V     | 20mA    |       |                                      |
| EBT.4802   | 48V     | 25mA    | 1.2W  | T6848025                             |
| 68.48040   | 48V     | 40mA    |       | T6848040                             |
| 68.48050   | 48V     | 50mA    |       | T6848050                             |
| EBT.6002   | 60V     | 20mA    | 1.2W  | T6860020                             |
| 68.60040   | 60V     | 40mA    |       | T6860040                             |
| 68.60050   | 60V     | 50mA    |       | T6860050                             |
| 68.60060   | 60V     | 60mA    |       | T6860060                             |
| 68.70020   | 70V     | 20mA    |       | T6870020                             |
| 68.110NE   | 110V    | 1.5A    |       | Glow lamp w with integrated resistor |
| 68.220GF   | 220V    | 1.5A    |       | Fluorescent integrated resistor      |
| EBT.G220   | 220V    | 1.5A    |       | Neon for green lenses                |

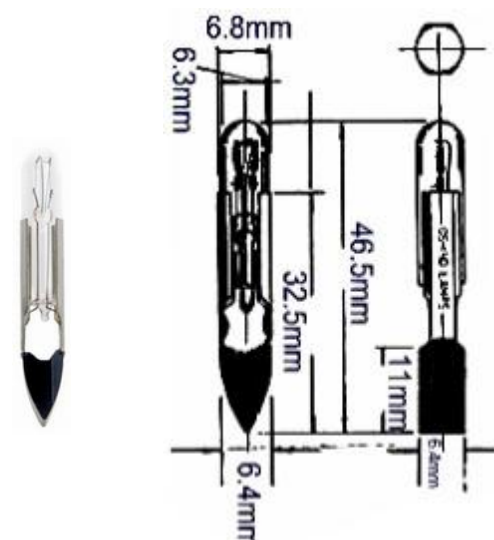

| <b>Glow Lamps with 150mm Cable</b> |         |         |                    |
|------------------------------------|---------|---------|--------------------|
| Order No                           | Voltage | Cut Out | Colour             |
| ESEA64                             | 220VAC  | 6mm     | yellow transparent |
| ESEA65                             |         |         | green transparent  |
| ESEA69                             |         |         | clear transparent  |
| ESEA62                             |         |         | red transparent    |
|                                    |         |         |                    |
|                                    |         |         |                    |

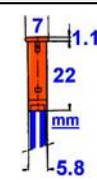

| <b>Glow Lamps with Fast-On 6.3x0.8mm</b> |         |         |                    |
|--|---------|---------|--------------------|
| Order No                                 | Voltage | Cut Out | Colour             |
| ESEC104                                  | 220VAC  | 10mm    | yellow transparent |
| ESEC105                                  |         |         | green transparent  |
| ESEC102                                  |         |         | red transparent    |
|  |         |         |                    |
|  |         |         |                    |

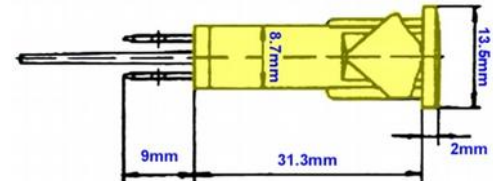

| <b>Glow Lamps with Fast-On 6.3x0.8mm</b> |         |         |                    |
|--|---------|---------|--------------------|
| Order No                                 | Voltage | Cut Out | Colour             |
| ESED134                                  | 220VAC  | 13mm    | yellow transparent |
| ESED135                                  |         |         | green transparent  |
| ESED132                                  |         |         | red transparent    |
|  |         |         |                    |
|  |         |         |                    |
|  |         |         |                    |
|  |         |         |                    |

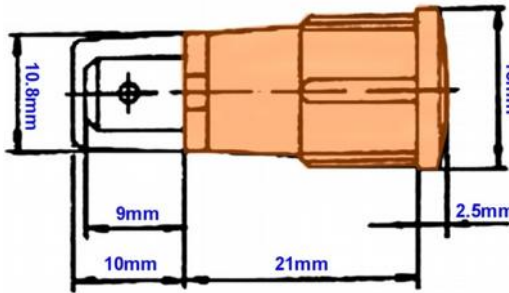



**Indicator Light with Fast-On 6.3x0.8mm**

| Order No                  | Voltage | Size    | Colour |
|---------------------------|---------|---------|--------|
| <a href="#">SAN.85143</a> | 230V    | 14x43mm | yellow |
| <a href="#">SAN.BGL22</a> | 230V    | 22x30mm | red    |
| <a href="#">SAN.85002</a> | 230V    | 22x30mm | yellow |
|                           |         |         |        |
|                           |         |         |        |



**Ba9s Light Bulb Sockets**

| Order No               | Socket | Description           |
|------------------------|--------|-----------------------|
| <a href="#">EEU.B9</a> | Ba9s   | With solder tags      |
| <a href="#">EEO.B9</a> |        | With solder tags      |
| <a href="#">EFA.R9</a> |        | With solder tags      |
| <a href="#">EFB.B9</a> |        | With solder tags      |
| <a href="#">EEA.B9</a> |        | Vertical PCB mounting |
|                        |        |                       |
|                        |        |                       |
|                        |        |                       |
|                        |        |                       |
|                        |        |                       |



**E10 Light Bulb Sockets**

| Order No               | Socket | Description                 |
|------------------------|--------|-----------------------------|
| <a href="#">EEO.B9</a> | E10    | With solder tags            |
| <a href="#">EHA</a>    |        | With solder tags            |
| <a href="#">EHA.H1</a> |        | Mounting piece fits EHA     |
| <a href="#">EHA.H2</a> |        | Mounting piece 90° fits EHA |
| <a href="#">EFA.R9</a> |        | With solder tags            |
| <a href="#">EEG</a>    |        | With solder tags            |
| <a href="#">EEC</a>    |        | Horizontal PCB mounting     |
| <a href="#">EEB</a>    |        | Vertical PCB mounting       |
| <a href="#">EEA.B9</a> |        | Vertical PCB mounting       |
| <a href="#">EGA.0</a>  |        | Screw terminal              |
|                        |        |                             |
|                        |        |                             |
|                        |        |                             |
|                        |        |                             |
|                        |        |                             |
|                        |        |                             |



**E10 Light Bulb Sockets**

| Order No              | Socket | Description               |
|-----------------------|--------|---------------------------|
| <a href="#">ESB.6</a> | E10    | Signal lamp holder blue   |
| <a href="#">ESB.9</a> |        | Signal lamp holder clear  |
| <a href="#">ESB.5</a> |        | Signal lamp holder green  |
| <a href="#">ESB.3</a> |        | Signal lamp holder orange |
| <a href="#">ESB.2</a> |        | Signal lamp holder red    |

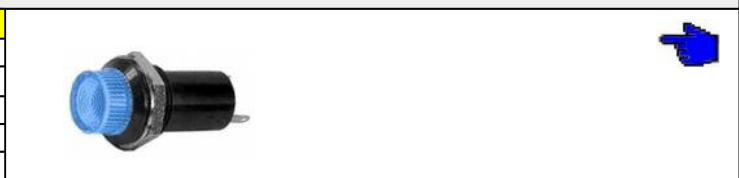





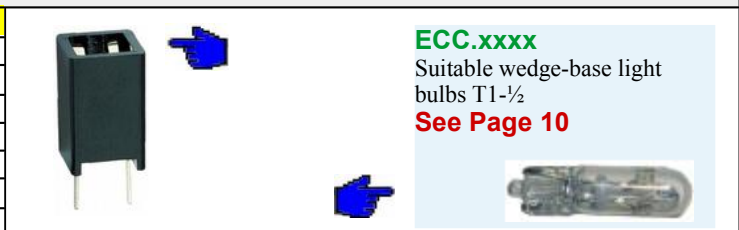

**W2x4.6d Light Bulb Socket**





















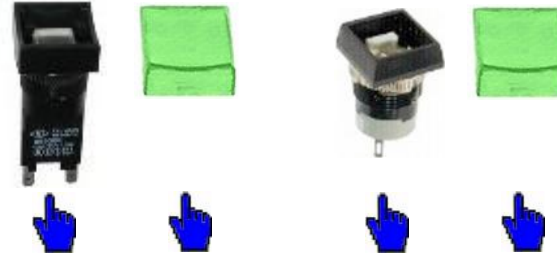

| Order No            | Socket  | Description                      |
|---------------------|---------|----------------------------------|
| <a href="#">EBB</a> | W2x4.6d | PCB mounting for wedge base T1-½ |
|                     |         |                                  |
|                     |         |                                  |
|                     |         |                                  |
|                     |         |                                  |





**TH25 Indicator Lamp**

| Order No   | Suitable Lenses |         |       |         |         |         |
|--|-----------------|---------|-------|---------|---------|---------|
|  | blue            | yellow  | green | orange  | red     | clear   |
| ESP  | SAL.RK6         | SAL.RK4 |       | SAL.RK3 | SAL.RK2 | SAL.RK9 |
| <p><b>EBP.xxxx or 33.xxxxx</b><br/>Suitable bi-pin bulbs<br/><b>See Page 9</b></p>     |                 |         |       |         |         |         |
| <p>Or use 5mm LEDs</p>      |                 |         |       |         |         |         |

**TH5 + TH25 Indicator Lamp**

| Order No  | Suitable Lenses |         |         |         |         |         |
|---|-----------------|---------|---------|---------|---------|---------|
|   | blue            | yellow  | green   | orange  | red     | clear   |
| ESM.A   | SAL.AK6         | SAL.AK4 | SAL.AK5 | SAL.AK3 | SAL.AK2 | SAL.AK9 |
| ESW.AA  | SAR.AK6         | SAR.AK4 | SAR.AK5 | SAR.AK3 | SAR.AK2 | SAR.AK9 |
| <p><b>EBM.xxxx or 65.xxxxx</b><br/>Suitable light bulbs T1-3/4 Midget Groove<br/><b>See Page 12</b></p>      |                 |         |         |         |         |         |
|                |                 |         |         |         |         |         |
| Order No  | Suitable Lenses |         |         |         |         |         |
|   | blue            | yellow  | green   | orange  | red     | clear   |
| ESM.B   | SAL.BK6         | SAL.BK4 | SAL.BK5 | SAL.BK3 | SAL.BK2 | SAL.BK9 |
| ESW.AB  | SAR.BK6         | SAR.BK4 | SAR.BK5 | SAR.BK3 | SAR.BK2 | SAR.BK9 |
| <p><b>EBM.xxxx or 65.xxxxx</b><br/>Suitable light bulbs T1-3/4 Midget Groove<br/><b>See Page 12</b></p>     |                 |         |         |         |         |         |
|       |                 |         |         |         |         |         |
| Order No  | Suitable Lenses |         |         |         |         |         |
|   | blue            | yellow  | green   | orange  | red     | clear   |
| ESM.C   | SAL.CK6         | SAL.CK4 | SAL.CK5 | SAL.CK3 | SAL.CK2 | SAL.CK9 |
| ESW.AC  | SAR.CK6         | SAR.CK4 | SAR.CK5 | SAR.CK3 | SAR.CK2 | SAR.CK9 |
| <p><b>EBM.xxxx or 65.xxxxx</b><br/>Suitable light bulbs T1-3/4 Midget Groove<br/><b>See Page 12</b></p>      |                 |         |         |         |         |         |
|      |                 |         |         |         |         |         |

**T4.6 Signal Lamp with Solder Terminal**

| Order No | Colour | Ø    |   |
|----------|--------|------|---|
| ESU.4    | yellow | 11mm | <p><b>EBU.xxxx or 46.xxxxx</b><br/>Suitable telecommunication bulbs T4.6<br/><b>See Page 12</b></p>    |
| ESU.5    | green  |      |   |
| ESU.9    | clear  |      |   |
| ESU.2    | red    |      |   |
|          |        |      |   |
|          |        |      |   |
|          |        |      |   |
|          |        |      |   |
|          |        |      |   |



**Signal Lights (for incandescent bulbs and glow lamps)**

| Order No  | Colour | Description       |
|-----------|--------|-------------------|
| ESD.FD174 | yellow | Arrow             |
| ESD.FD179 | clear  |                   |
| ESD.FD172 | red    |                   |
| ESD.FC144 | yellow | Square<br>14x14mm |
| ESD.FC145 | green  |                   |
| ESD.FC149 | clear  |                   |
| ESD.FC142 | red    |                   |
| ESD.FA124 | yellow | Round 12mm        |
| ESD.FA125 | green  |                   |
| ESD.FA129 | clear  |                   |
| ESD.FA122 | red    |                   |

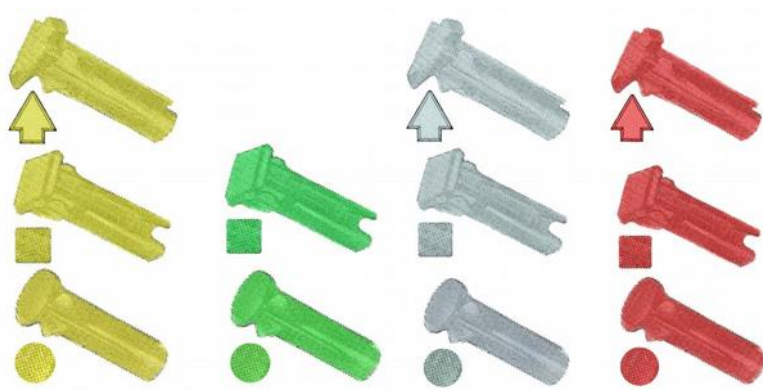

**ESD.xxxx**

Suitable incandescent bulbs and glow lamps

**See Page 15**

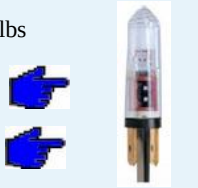

**Subminiature Lamps (fits T<sup>3</sup>/<sub>4</sub> Micro Midget Flange Light Bulbs)**

| Order No | Colour | Description  |
|----------|--------|--------------|
| ESY.6    | blue   | PCB mounting |
| ESY.4    | yellow |              |
| ESY.5    | green  |              |
| ESY.9    | clear  |              |
|          |        |              |
|          |        |              |
|          |        |              |
|          |        |              |
|          |        |              |
|          |        |              |
|          |        |              |
|          |        |              |
|          |        |              |

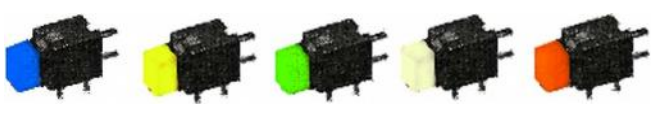

**EBX.xxxx or 26.xxxxx**

Suitable light bulbs  
Micro Midget Flange

**See Page 8**

