

# Widerstände

Preise siehe [shop.griederbauteile.ch](http://shop.griederbauteile.ch)

<b>Widerstände – Allgemeines</b>	<b>Seite 2</b>					
<b>Miniatur Metallfilm-Widerstände 0.5 Watt</b>	<b>Seite 3</b>					
<b>Hochohm Widerstände 0.25W/0.5W</b>	<b>Seite 3</b>					
<b>Metallfilm-Widerstände 0.6 Watt 1% ±50ppm</b>	<b>Seite 4 + 5</b>					
<b>Metallfilm-Widerstände 0.6 Watt 1% + 0.1% ±25ppm</b>	<b>Seite 6</b>					
<b>Metallfilm-Widerstände 0.6 Watt 5%</b>	<b>Seite 6</b>					
<b>Metallfilm-Widerstände 0.25W 0.5W 1W 5%</b>	<b>Seite 7</b>					
<b>Metallfilm-Widerstände 1W 2W 3W 5%</b>	<b>Seite 8</b>					
<b>Draht-Widerstände 1W – 17W</b>	<b>Seite 9 + 10</b>					
<b>Draht-Widerstands-Zubehör</b>	<b>Seite 10</b>					
<b>Draht-Widerstände mit Abgriffschelle 10 - 100W</b>	<b>Seite 11</b>					
<b>Draht-Widerstände mit/ohne Abgriffschelle 12 - 250W</b>	<b>Seite 12</b>					
<b>Draht-Widerstände in Alugehäuse 10 - 100W</b>	<b>Seite 13</b>					
<b>Widerstands-Netzwerke</b>	<b>Seite 14</b>					

**Der Widerstandsaufdruck in Klarschrift**

Meistens fehlt das Zeichen Ohm und nur der Buchstabe der Grössenordnung ist angegeben. Toleranz und Belastbarkeit können fehlen, wenn die Typenbezeichnung vorliegt.

Z.B. 30K 10% aber auch 30K VTM 19050 oder 30K VTM 216-0.

**Der Widerstandsaufdruck nach IEC**

Das Zeichen Ohm und das Komma entfallen, die Buchstaben R, k (oder K), M und G geben die Grössenordnung an und ersetzen, wo nötig, das Komma. Die Toleranzangabe erfolgt in Klarschrift, oder durch Buchstaben (früher A = 10%, B = 5% neuerdings nach MIL) oder entfällt wenn eine Typenbezeichnung aufgedruckt ist.

Z.B. R10 = 0.1Ω, 1R8 = 1.8Ω, 100R oder k10 = 100Ω, 100k oder M10 = 100kΩ

**Der Widerstandsaufdruck nach MIL**

Im Prinzip wie nach IEC, für Werte unter 100Ω ist anstelle des Kommas der Buchstaben R gesetzt. Für Werte ab 100Ω entsprechen die ersten drei Stellen dem Zahlenwert. Die vierte Stelle nennt die Anzahl nachfolgenden Nullen. Der Schlussbuchstabe ergibt die Toleranz.

Z.B. 30R1F = 30.1Ω 1%, 1002C = 10kΩ 0.25%, 9090B = 909Ω 0.1%

B = ± 0.1%	G = ± 2%	M = ± 20%	S = +50% -20%	W = +20% -0%
C = ± 0.25%	H = ± 2.5%	N = ± 30%	T = +50% -10%	Y = +50% -0%
D = ± 0.5%	J = ± 5%	Q = +30% -10%	U = +80% -0%	Z = +80% -20%
F = ± 1%	K = ± 10%	R = +30% - 20%	V = +100% -10%	

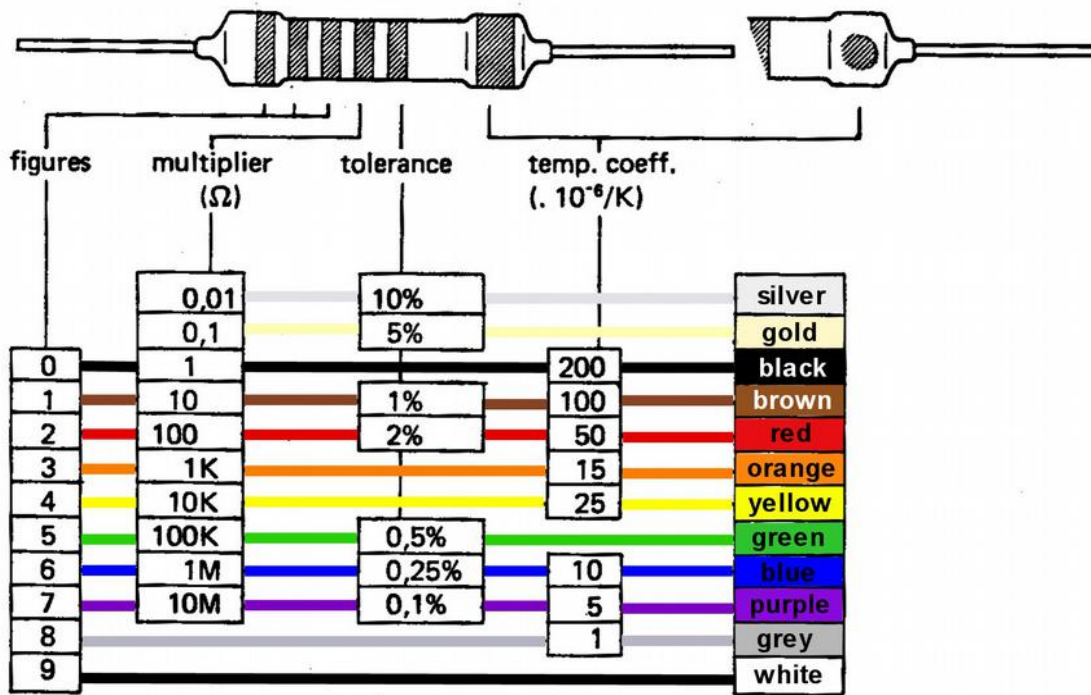

"figures" sind die ersten zwei oder drei Zahlenwerte aus der Normreihe IEC 63, z.B.: rot - violett - gelb - rot - braun - gelb = 27,4kOhm, +/-1%, 25ppm

**Miniatur Metallfilm-Widerstände 0.5 Watt**

Belastbarkeit (P70): 0.5W bei 70°C  
 UR max: 200Veff (zw ischen den Anschlüssen des Widerstandes)  
 Ui max: 200Veff (zulässige Spannung gegen Umgebung)  
 Toleranz: ± 5%  
 Temperaturbereich: -55°C bis +155°C  
 Temperaturkoeffizient bis 4.7Ω und ab 100kΩ: ± 250ppm/K  
 Temperaturkoeffizient 4.7Ω bis 100kΩ: ± 100ppm/K  
 Langzeitstabilität: 1% +0.05Ω bei P70 = 0.5W  
 Rauschspannung: bis 68kΩ: 0.1uV/V  
 Rauschspannung ab 68kΩ bis 100kΩ: 0.5uV/V  
 Rauschspannung ab 100kΩ: 1.5uV/V  
 Widerstandsbereich: 1Ω bis 2.2MΩ (Serie E12)

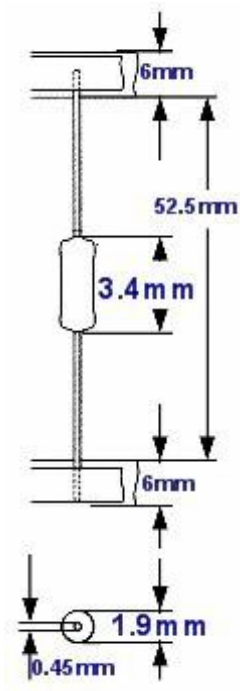

Best.Nr.	Wert in Ω	Best.Nr.	Wert in Ω	Best.Nr.	Wert in Ω
RIA.1R0	1	RIA.180R	180	RIA.22k	22k
RIA.1R2	1.2	RIA.220R	220	RIA.27k	27k
RIA.1R5	1.5	RIA.270R	270	RIA.33k	33k
RIA.1R8	1.8	RIA.330R	330	RIA.39k	39k
RIA.2R2	2.2	RIA.390R	390	RIA.47k	47k
RIA.2R7	2.7	RIA.470R	470	RIA.56k	56k
RIA.3R3	3.3	RIA.560R	560	RIA.68k	68k
RIA.3R9	3.9	RIA.680R	680	RIA.82k	82k
RIA.4R7	4.7	RIA.820R	820	RIA.100k	100k
RIA.5R6	5.6	RIA.1k0	1k	RIA.120k	120k
RIA.6R8	6.8	RIA.1k2	1.2k	RIA.150k	150k
RIA.8R2	8.2	RIA.1k5	1.5k	RIA.180k	180k
RIA.10R	10	RIA.1k8	1.8k	RIA.220k	220k
RIA.12R	12	RIA.2k2	2.2k	RIA.270k	270k
RIA.15R	15	RIA.2k7	2.7k	RIA.330k	330k
RIA.18R	18	RIA.3k3	3.3k	RIA.390k	390k
RIA.22R	22	RIA.3k9	3.9k	RIA.470k	470k
RIA.27R	27	RIA.4k7	4.7k	RIA.560k	560k
RIA.33R	33	RIA.5k6	5.6k	RIA.680k	680k
RIA.39R	39	RIA.5k9	5.9k	RIA.820k	820k
RIA.47R	47	RIA.6k2	6.2k	RIA.1M0	1M
RIA.56R	56	RIA.6k8	6.8k	RIA.1M2	1.2M
RIA.68R	68	RIA.8k2	8.2k	RIA.1M5	1.5M
RIA.82R	82	RIA.10k	10k	RIA.1M8	1.8M
RIA.100R	100	RIA.12k	12k	RIA.2M2	2.2M
RIA.120R	120	RIA.15k	15k	RIA.2M21	2.21M
RIA.150R	150	RIA.18k	18k	RIA.2M7	2.7M

**Hochohm-Widerstände**

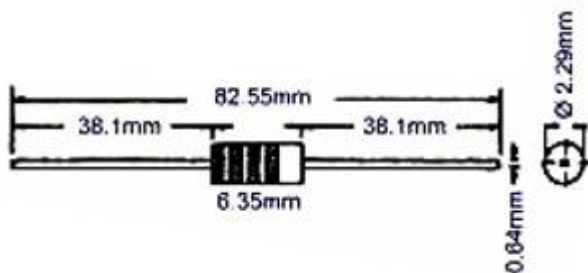

Bauform B

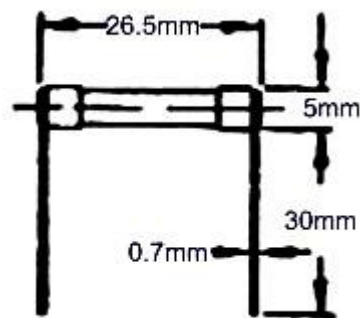

Bauform A

Best.Nr.	Wert	Leistung	U max	Toleranz	Bauform
RIH.50M	50M Ω	0.5 Watt	350V	20%	A
RIH.100M	100M Ω	0.25 Watt	250V	20%	B
RIH.160M	160M Ω	0.5 Watt	350V	20%	A
RIH.200M	200M Ω	0.5 Watt	350V	20%	A



**Metallfilm-Widerstände 0.6W Tol=1% ±50ppm (E48-Reihe)**

Belastbarkeit @ Tamb 70°C: 0.6W (P70)  
 Spannungsfestigkeit: 300VDC, 424VRMS  
 Toleranz: ±1.0%  
 Temperaturkoeffizient: ±50ppm°C

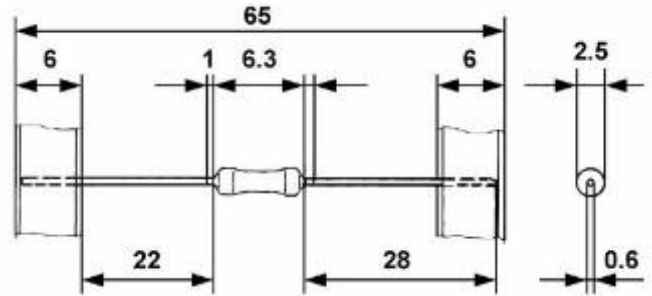

Best.Nr.	Wert in Ω	Best.Nr.	Wert in Ω	Best.Nr.	Wert in Ω	Best.Nr.	Wert in Ω	Best.Nr.	Wert in Ω	Best.Nr.	Wert in Ω	Best.Nr.	Wert in Ω
RMF.R22	0.22											RMF.10M0	10M
RMF.1R00	1	RMF.10R0	10	RMF.100R	100	RMF.1K00	1K	RMF.10K0	10K	RMF.100K	100K	RMF.1M00	1M
RMF.1R05	1.05	RMF.10R5	10.5	RMF.105R	105	RMF.1K05	1.05K	RMF.10K5	10.5K	RMF.105K	105K	RMF.1M05	1.05M
RMF.1R10	1.1	RMF.11R0	11	RMF.110R	110	RMF.1K10	1.1K	RMF.11K0	11K	RMF.110K	110K	RMF.1M10	1.1M
RMF.1R15	1.15	RMF.11R5	11.5	RMF.115R	115	RMF.1K15	1.15K	RMF.11K5	11.5K	RMF.115K	115K	RMF.1M15	1.15M
				RMF.120R	120	RMF.1K24	1.24K						
RMF.1R21	1.21	RMF.12R1	12.1	RMF.121R	120	RMF.1K21	1.21K	RMF.12K1	12.1K	RMF.121K	121K	RMF.1M21	1.21M
RMF.1R27	1.27	RMF.12R7	12.7	RMF.127R	127	RMF.1K27	1.27K	RMF.12K7	12.7K	RMF.127K	127K	RMF.1M27	1.27M
RMF.1R30	1.3	RMF.13R0	13	RMF.130R	130	RMF.1K30	1.3K	RMF.13K0	13K	RMF.130K	130K	RMF.1M30	1.3M
RMF.1R33	1.33	RMF.13R3	13.3	RMF.133R	133	RMF.1K33	1.33K	RMF.13K3	13.3K	RMF.133K	133K	RMF.1M33	1.33M
RMF.1R40	1.4	RMF.14R0	14	RMF.140R	140	RMF.1K40	1.4K	RMF.14K0	14K	RMF.140K	140K	RMF.1M40	1.4M
RMF.1R47	1.47	RMF.14R7	14.7	RMF.147R	147	RMF.1K47	1.47K	RMF.14K7	14.7K	RMF.147K	147K	RMF.1M47	1.47M
RMF.1R50	1.5	RMF.15R0	15	RMF.150R	150	RMF.1K50	1.5K	RMF.15K0	15K	RMF.150K	150K	RMF.1M50	1.5M
RMF.1R54	1.54	RMF.15R4	15.4	RMF.154R	154	RMF.1K54	1.54K	RMF.15K4	15.4K	RMF.154K	154K	RMF.1M54	1.54M
RMF.1R62	1.62	RMF.16R2	16.2	RMF.162R	162	RMF.1K62	1.62K	RMF.16K2	16.2K	RMF.162K	162K	RMF.1M62	1.62M
						RMF.1K65	1.65K			RMF.165K	165K		
RMF.1R69	1.69	RMF.16R9	16.9	RMF.169R	169	RMF.1K69	1.69K	RMF.16K9	16.9K	RMF.169K	169K	RMF.1M69	1.69M
RMF.1R78	1.78	RMF.17R8	17.8	RMF.178R	178	RMF.1K78	1.78K	RMF.17K8	17.8K	RMF.178K	178K	RMF.1M78	1.78M
RMF.1R82	1.82	RMF.18R2	18.2	RMF.182R	182	RMF.1K82	1.82K	RMF.18K2	18.2K	RMF.182K	182K	RMF.1M82	1.82M
RMF.1R87	1.87	RMF.18R7	18.7	RMF.187R	187	RMF.1K87	1.87K	RMF.18K7	18.7K	RMF.187K	187K	RMF.1M87	1.87M
RMF.1R96	1.96	RMF.19R6	19.6	RMF.196R	196	RMF.1K96	1.96K	RMF.19K6	19.6K	RMF.196K	196K	RMF.1M96	1.96M
RMF.2R00	2	RMF.20R0	20	RMF.200R	200	RMF.2K00	2K	RMF.20K0	20K	RMF.200K	200K	RMF.2M00	2M
RMF.2R05	2.05	RMF.20R5	20.5	RMF.205R	205	RMF.2K05	2.05K	RMF.20K5	20.5K	RMF.205K	205K	RMF.2M05	2.05M
RMF.2R10	2.1	RMF.21R0	21	RMF.210R	210	RMF.2K10	2.1K	RMF.21K0	21K	RMF.210K	210K	RMF.2M10	2.1M
RMF.2R15	2.15	RMF.21R5	21.5	RMF.215R	215	RMF.2K15	2.15K	RMF.21K5	21.5K	RMF.215K	215K	RMF.2M15	2.15M
								RMF.22K0	22K				
RMF.2R21	2.21	RMF.22R1	22.1	RMF.221R	221	RMF.2K21	2.21K	RMF.22K1	22.1K	RMF.221K	221K	RMF.2M21	2.21M
RMF.2R26	2.26	RMF.22R6	22.6	RMF.226R	226	RMF.2K26	2.26K	RMF.22K6	22.6K	RMF.226K	226K	RMF.2M26	2.26M
RMF.2R37	2.37	RMF.23R7	23.7	RMF.237R	237	RMF.2K37	2.37K	RMF.23K7	23.7K	RMF.237K	237K	RMF.2M37	2.37M
RMF.2R43	2.43	RMF.24R3	24.3	RMF.243R	243	RMF.2K43	2.43K	RMF.24K3	24.3K	RMF.243K	243K	RMF.2M43	2.43M
RMF.2R49	2.49	RMF.24R9	24.9	RMF.249R	249	RMF.2K49	2.49K	RMF.24K9	24.9K	RMF.249K	249K	RMF.2M49	2.49M
RMF.2R55	2.55	RMF.25R5	25.5	RMF.255R	255	RMF.2K55	2.55K	RMF.25K5	25.5K	RMF.255K	255K	RMF.2M55	2.55M
RMF.2R61	2.61	RMF.26R1	26.1	RMF.261R	261	RMF.2K61	2.61K	RMF.26K1	26.1K	RMF.261K	261K	RMF.2M61	2.61M
RMF.2R67	2.67	RMF.26R7	26.7	RMF.267R	267	RMF.2K67	2.67K	RMF.26K7	26.7K	RMF.267K	267K	RMF.2M67	2.67M
RMF.2R74	2.74	RMF.27R4	27.4	RMF.274R	274	RMF.2K74	2.74K	RMF.27K4	27.4K	RMF.274K	274K	RMF.2M74	2.74M
RMF.2R87	2.87	RMF.28R7	28.7	RMF.287R	287	RMF.2K87	2.87K	RMF.28K7	28.7K	RMF.287K	287K	RMF.2M87	2.87M
RMF.3R01	3.01	RMF.30R1	30.1	RMF.301R	301	RMF.3K01	3.01K	RMF.30K1	30.1K	RMF.301K	301K	RMF.3M01	3.01M
RMF.3R16	3.16	RMF.31R6	31.6	RMF.316R	316	RMF.3K16	3.16K	RMF.31K6	31.6K	RMF.316K	316K	RMF.3M16	3.16M
								RMF.33K0	33K				
RMF.3R32	3.32	RMF.33R2	33.2	RMF.332R	332	RMF.3K32	3.32K	RMF.33K2	33.2K	RMF.332K	332K	RMF.3M32	3.32M
RMF.3R48	3.48	RMF.34R8	34.8	RMF.348R	348	RMF.3K48	3.48K	RMF.34K8	34.8K	RMF.348K	348K	RMF.3M48	3.48M
RMF.3R57	3.57	RMF.35R7	35.7	RMF.357R	357	RMF.3K57	3.57K	RMF.35K7	35.7K	RMF.357K	357K	RMF.3M57	3.57M
RMF.3R65	3.65	RMF.36R5	36.5	RMF.365R	365	RMF.3K65	3.65K	RMF.36K5	36.5K	RMF.365K	365K	RMF.3M65	3.65M
RMF.3R83	3.83	RMF.38R3	38.3	RMF.383R	383	RMF.3K83	3.83K	RMF.38K3	38.3K	RMF.383K	383K	RMF.3M83	3.83M
RMF.3R92	3.92	RMF.39R2	39.2	RMF.392R	392	RMF.3K92	3.92K	RMF.39K2	39.2K	RMF.392K	392K	RMF.3M92	3.92M

weitere Typen bis 10MΩ auf der nächsten Seite



**Fortsetzung Metallfilm-Widerstände 0.6W Tol=1% ±50ppm (E48-Reihe)**

Belastbarkeit @ Tamb 70°C: 0.6W (P70)  
 Spannungsfestigkeit: 300VDC, 424VRMS  
 Toleranz: ±1.0%  
 Temperaturkoeffizient: ±50ppm°C

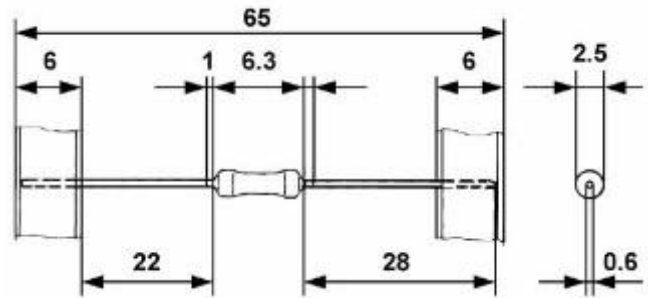

Best.Nr.	Wert in Ω	Best.Nr.	Wert in Ω	Best.Nr.	Wert in Ω	Best.Nr.	Wert in Ω	Best.Nr.	Wert in Ω	Best.Nr.	Wert in Ω	Best.Nr.	Wert in Ω
RMF.4R02	4.02	RMF.40R2	40.2	RMF.402R	402	RMF.4K02	4.02K	RMF.40K2	40.2K	RMF.402K	402K	RMF.4M02	4.02M
RMF.4R22	4.22	RMF.42R2	42.2	RMF.422R	422	RMF.4K22	4.22K	RMF.42K2	42.2K	RMF.422K	422K	RMF.4M22	4.22M
RMF.4R32	4.32	RMF.43R2	43.2	RMF.432R	432	RMF.4K32	4.32K	RMF.43K2	43.2K	RMF.432K	432K	RMF.4M32	4.32M
RMF.4R42	4.42	RMF.44R2	44.2	RMF.442R	442	RMF.4K42	4.42K	RMF.44K2	44.2K	RMF.442K	442K	RMF.4M42	4.42M
RMF.4R64	4.64	RMF.46R4	46.4	RMF.464R	464	RMF.4K64	4.64K	RMF.46K4	46.4K	RMF.464K	464K	RMF.4M64	4.64M
RMF.4R75	4.75	RMF.47R5	47.5	RMF.475R	475	RMF.4K75	4.75K	RMF.47K5	47.5K	RMF.475K	475K	RMF.4M75	4.75M
RMF.4R87	4.87	RMF.48R7	48.7	RMF.487R	487	RMF.4K87	4.87K	RMF.48K7	48.7K	RMF.487K	487K	RMF.4M87	4.87M
RMF.4R99	4.99	RMF.49R9	49.9	RMF.499R	499	RMF.4K99	4.99K	RMF.49K9	49.9K	RMF.499K	499K	RMF.4M99	4.99M
RMF.5R11	5.11	RMF.51R1	51.1	RMF.511R	511	RMF.5K11	5.11K	RMF.51K1	51.1K	RMF.511K	511K	RMF.5M11	5.11M
		RMF.52R3	52.3										
RMF.5R36	5.36	RMF.53R6	53.6	RMF.536R	536	RMF.5K36	5.36K	RMF.53K6	53.6K	RMF.536K	536K	RMF.5M36	5.36M
		RMF.56R0	56										
RMF.5R62	5.62	RMF.56R2	56.2	RMF.562R	562	RMF.5K62	5.62K	RMF.56K2	56.2K	RMF.562K	562K	RMF.5M62	5.62M
RMF.5R90	5.9	RMF.59R0	59	RMF.590R	590	RMF.5K90	5.9K	RMF.59K0	59K	RMF.590K	590K	RMF.5M90	5.9M
				RMF.600R	600								
RMF.6R19	6.19	RMF.61R9	61.9	RMF.619R	619	RMF.6K19	6.19K	RMF.61K9	61.9K	RMF.619K	619K	RMF.6M19	6.19M
						RMF.6K20	6.2K						
RMF.6R49	6.49	RMF.64R9	64.9	RMF.649R	649	RMF.6K49	6.49K	RMF.64K9	64.9K	RMF.649K	649K	RMF.6M49	6.49M
RMF.6R81	6.81	RMF.68R1	68.1	RMF.681R	681	RMF.6K81	6.81K	RMF.68K1	68.1K	RMF.681K	681K	RMF.6M81	6.81M
RMF.6R98	6.98	RMF.69R8	69.8	RMF.698R	698	RMF.6K98	6.98K	RMF.69K8	69.8K	RMF.698K	698K	RMF.6M98	6.98M
RMF.7R15	7.15	RMF.71R5	71.5	RMF.715R	715	RMF.7K15	7.15K	RMF.71K5	71.5K	RMF.715K	715K	RMF.7M15	7.15M
RMF.7R50	7.5	RMF.75R0	75	RMF.750R	750	RMF.7K50	7.5K	RMF.75K0	75K	RMF.750K	750K	RMF.7M50	7.5M
						RMF.7K68	7.68K						
RMF.7R87	7.87	RMF.78R7	78.7	RMF.787R	787	RMF.7K87	7.87K	RMF.78K7	78.7K	RMF.787K	787K	RMF.7M87	7.87M
RMF.8R25	8.25	RMF.82R5	82.5	RMF.825R	825	RMF.8K25	8.25K	RMF.82K5	82.5K	RMF.825K	825K	RMF.8M25	8.25M
RMF.8R66	8.66	RMF.86R6	86.6	RMF.866R	866	RMF.8K66	8.66K	RMF.86K6	86.6K	RMF.866K	866K	RMF.8M66	8.66M
RMF.9R09	9.09	RMF.90R9	90.9	RMF.909R	909	RMF.9K09	9.09K	RMF.90K9	90.9K	RMF.909K	909K	RMF.9M09	9.09M
RMF.9R53	9.53	RMF.95R3	95.3	RMF.953R	953	RMF.9K53	9.53K	RMF.95K3	95.3K	RMF.953K	953K	RMF.9M53	9.53M
RMF.9R76	9.76	RMF.97R6	97.6	RMF.976R	976	RMF.9K76	9.76K	RMF.97K6	97.6K	RMF.976K	976K	RMF.9M76	9.76M
												RMF.10M0	10M

**Metallfilm-Widerstände 0.6W Tol=1% Tol=0.1% ±25ppm**

Belastbarkeit @ Tamb 70°C: 0.6W (P70)  
 Spannungsfestigkeit: 300VDC, 424VRMS  
 Toleranz: ±1.0%  
 Temperaturkoeffizient: ±25ppm/°C

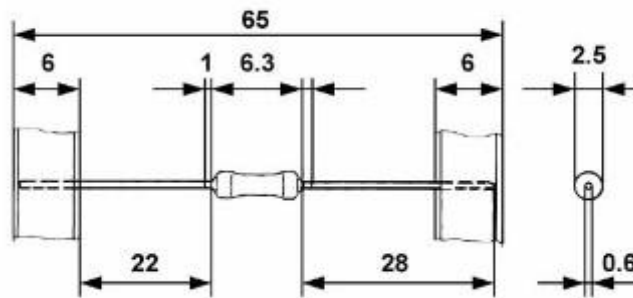

Best.Nr.	Wert in Ω	Best.Nr.	Wert in Ω	Best.Nr.	Wert in Ω	Best.Nr.	Wert in Ω	Best.Nr.	Wert in Ω
RMW.R01	0.01								
RMW.R9	0.9								
RMW.9R	9								
RMP.10R0	10	RMP.100R	100	RMP.1K00	1k	RMP.10K0	10k	RMP.100K	100k
RMP.18R0	18	RMP.110R	110	RMP.1K82	1.82k	RMP.12K7	12.7k	RMP.188K23	188.23k
RMP.82R5	82.5	RMP.161R1	161.1	RMP.2K00	2k	RMP.16K00	16k		
		RMP.178R7	178.7	RMP.2K20	2.2k	RMP.20K0	20k		
		RMP.181R3	181.3	RMP.2K40	2.4k	RMP.24K9	24.9k		
		RMP.182R8	182.8	RMP.2K717	2.717k	RMP.30K1	30.1k		
		RMP.232R	232	RMP.3K32	3.32k	RMP.33K2	33.2k		
		RMP.243R	243	RMP.4K41	4.41k	RMP.47K0	47k		
		RMP.10.250R	250	RMP.4K921	4.921k	RMP.48K7	48.7k		
		RMP.250R	250	RMP.5K177	5.177k	RMP.75K0	75k		
		RMP.270R	270	RMP.5K263	5.263k				
		RMP.681R	681	RMP.5K35	5.35k				
		RMP.904R5	904.5	RMP.5K442	5.442k				
				RMP.5K534	5.534k				
				RMP.5K724	5.724k				



**Metallfilm-Widerstände 0.6W Tol=5% ±50ppm**

Belastbarkeit @ Tamb 70°C: 0.6W (P70)  
 Toleranz: ±5%  
 Temperaturkoeffizient: ±50 ppm/K  
 Betriebsspannung (Umax): 300VAC/DC

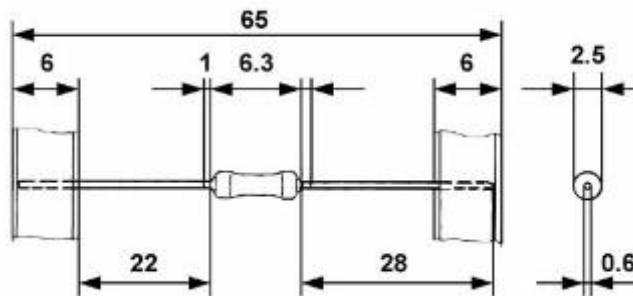

Best.Nr.	Wert in Ω								
RIB.R22	0.22								
RIB.R27	0.27								
RIB.R33	0.33								
RIB.R39	0.39								
RIB.R47	0.47								
RIB.R56	0.56								
RIB.R68	0.68								
RIB.R82	0.82								

**Metallfilm-Widerstand Tol=5%**

Belastbarkeit @ Tamb 70°C: **0.25W** (P70) 1600VDC  
 Belastbarkeit @ Tamb 70°C: **0.5W** (P70) 3500VDC  
 Belastbarkeit @ Tamb 70°C: **1 W** (P70) 10000VDC  
 Toleranz: ±5% (0.25W ab 12M ±10%)  
 Temperaturkoeffizient: ±200ppm/°C

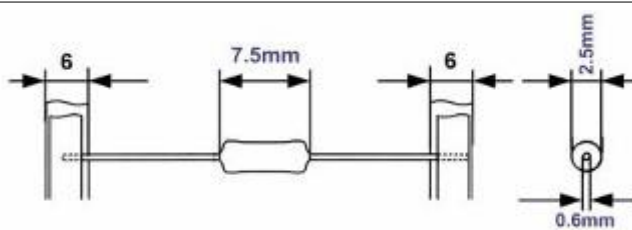

Wert in Ω	Best.Nr.	Best.Nr.	Best.Nr.
	<b>0.25 W</b>	<b>0.5 Watt</b>	<b>1 Watt</b>
100k	RM G.02.100k	RM G.05.100k	RM G.10.100k
110k		RM G.05.110k	RM G.10.100k
120k	RM G.02.120k	RM G.05.120k	RM G.10.120k
130k		RM G.05.130k	RM G.10.130k
150k	RM G.02.150k	RM G.05.150k	RM G.10.150k
160k		RM G.05.160k	RM G.10.160k
180k	RM G.02.180k	RM G.05.180k	RM G.10.180k
200k		RM G.05.200k	RM G.10.200k
220k	RM G.02.220k	RM G.05.220k	RM G.10.220k
240k		RM G.05.240k	RM G.10.240k
270k	RM G.02.270k	RM G.05.270k	RM G.10.270k
300k		RM G.05.300k	RM G.10.300k
330k	RM G.02.330k	RM G.05.330k	RM G.10.330k
360k		RM G.05.360k	RM G.10.360k
390k	RM G.02.390k	RM G.05.390k	RM G.10.390k
430k		RM G.05.430k	RM G.10.430k
470k	RM G.02.470k	RM G.05.470k	RM G.10.470k
510k		RM G.05.510k	RM G.10.510k
560k	RM G.02.560k	RM G.05.560k	RM G.10.560k
620k		RM G.05.620k	RM G.10.620k
680k	RM G.02.680k	RM G.05.680k	RM G.10.680k
750k		RM G.05.750k	RM G.10.750k
820k	RM G.02.820k	RM G.05.820k	RM G.10.820k
910k		RM G.05.910k	RM G.10.910k
1M	RM G.02.1M0	RM G.05.1M0	RM G.10.1M0
1.1M		RM G.05.1M1	RM G.10.1M1
1.2M	RM G.02.1M2	RM G.05.1M2	RM G.10.1M2
1.3M		RM G.05.1M3	RM G.10.1M3
1.5M	RM G.02.1M5	RM G.05.1M5	RM G.10.1M5
1.6M		RM G.05.1M6	RM G.10.1M6
1.8M	RM G.02.1M8	RM G.05.1M8	RM G.10.1M8
2M		RM G.05.2M0	RM G.10.2M0
2.2M	RM G.02.2M2	RM G.05.2M2	RM G.10.2M2
2.4M		RM G.05.2M4	RM G.10.2M4
2.7M	RM G.02.2M7	RM G.05.2M7	RM G.10.2M7

Wert in Ω	Best.Nr.	Best.Nr.	Best.Nr.
	<b>0.25 W</b>	<b>0.5 Watt</b>	<b>1 Watt</b>
3M		RM G.05.3M0	RM G.10.3M0
3.3M	RM G.02.3M3	RM G.05.3M3	RM G.10.3M3
3.6M		RM G.05.3M6	RM G.10.3M6
3.9M	RM G.02.3M9	RM G.05.3M9	RM G.10.3M9
4.3M		RM G.05.4M3	RM G.10.4M3
4.7M	RM G.03.4M7	RM G.05.4M7	RM G.10.4M7
5.1M		RM G.05.5M1	RM G.10.5M1
5.6M	RM G.02.5M6	RM G.05.5M6	RM G.10.5M6
6.2M		RM G.05.6M2	RM G.10.6M2
6.8M	RM G.02.6M8	RM G.05.6M8	RM G.10.6M8
7.5M		RM G.05.7M5	RM G.10.7M5
8.2M	RM G.02.8M2	RM G.05.8M2	RM G.10.8M2
9.1M		RM G.05.9M1	RM G.10.9M1
10M	RM G.02.10M	RM G.05.10M	RM G.10.10M
11M		RM G.05.11M	RM G.10.11M
12M	RM G.02.12M	RM G.05.12M	RM G.10.12M
13M		RM G.05.13M	RM G.10.13M
15M	RM G.03.15M	RM G.05.15M	RM G.10.15M
16M		RM G.05.16M	RM G.10.16M
18M	RM G.02.18M	RM G.05.18M	RM G.10.18M
20M		RM G.05.20M	RM G.10.20M
22M	RM G.02.22M	RM G.05.22M	RM G.10.22M
24M		RM G.05.24M	RM G.10.24M
27M		RM G.05.27M	RM G.10.27M
30M		RM G.05.30M	RM G.10.30M
33M		RM G.05.33M	RM G.10.33M
36M		RM G.05.36M	RM G.10.36M
39M			RM G.10.39M
43M			RM G.10.43M
47M			RM G.10.47M
51M			RM G.10.51M
56M			RM G.10.56M
62M			RM G.10.62M
68M			RM G.10.68M

**Leistungs-Metallfilm-Widerstand Tol=5%**

Belastbarkeit @ Tamb 70°C: **1W** (P70) 350VDC  
 Belastbarkeit @ Tamb 70°C: **2W** (P70) 500VDC  
 Belastbarkeit @ Tamb 70°C: **3W** (P70) 750VDC  
 Toleranz: ±5, Temperaturkoeffizient: ±250ppm/°C

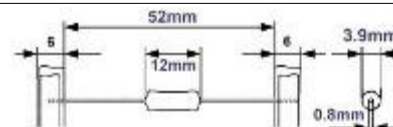

Wert in Ω	Best.Nr.	Best.Nr.	Best.Nr.
	<b>1 Watt</b>	<b>2 Watt</b>	<b>3 Watt</b>
1	RML.10.1R0	RML.16.1R0	RML.25.1R0
1.1		RML.16.1R1	RML.25.1R1
1.2	RML.10.1R2	RML.16.1R2	RML.25.1R2
1.3		RML.16.1R3	RML.25.1R3
1.5	RML.10.1R5	RML.16.1R5	RML.25.1R5
1.6		RML.16.1R6	RML.25.1R6
1.8	RML.10.1R8	RML.16.1R8	RML.25.1R8
2		RML.16.2R0	RML.25.2R0
2.2	RML.10.2R2	RML.16.2R2	RML.25.2R2
2.4		RML.16.2R4	RML.25.2R4
2.7	RML.10.2R7	RML.16.2R7	RML.25.2R7
3		RML.16.3R0	RML.25.3R0
3.3	RML.10.3R3	RML.16.3R3	RML.25.3R3
3.6		RML.16.3R6	RML.25.3R6
3.9	RML.10.3R9	RML.16.3R9	RML.25.3R9
4.3		RML.16.4R3	RML.25.4R3
4.7	RML.10.4R7	RML.16.4R7	RML.25.4R7
5.1		RML.16.5R1	RML.25.5R1
5.6	RML.10.5R6	RML.16.5R6	RML.25.5R6
6.2		RML.16.6R2	RML.25.6R2
6.8	RML.10.6R8	RML.16.6R8	RML.25.6R8
7.5		RML.16.7R5	RML.25.7R5
8.2	RML.10.8R2	RML.16.8R2	RML.25.8R2
9.1		RML.16.9R1	RML.25.9R1
10	RML.10.10R	RML.16.10R	RML.25.10R
11		RML.16.11R	RML.25.11R
12	RML.10.12R	RML.16.12R	RML.25.12R
13		RML.16.13R	RML.25.13R
15	RML.10.15R	RML.16.15R	RML.25.15R
16		RML.16.16R	RML.25.16R
18	RML.10.18R	RML.16.18R	RML.25.18R
20		RML.16.20R	RML.25.20R
22	RML.10.22R	RML.16.22R	RML.25.22R
24		RML.16.24R	RML.25.24R
27	RML.10.27R	RML.16.27R	RML.25.27R
30		RML.16.30R	RML.25.30R
33	RML.10.33R	RML.16.33R	RML.25.33R
36		RML.16.36R	RML.25.36R
39	RML.10.39R	RML.16.39R	RML.25.39R
43		RML.16.43R	RML.25.43R
47	RML.10.47R	RML.16.47R	RML.25.47R
51		RML.16.51R	RML.25.51R
56	RML.10.56R	RML.16.56R	RML.25.56R
62		RML.16.62R	RML.25.62R
68	RML.10.68R	RML.16.68R	RML.25.68R
75		RML.16.75R	RML.25.75R
82	RML.10.82R	RML.16.82R	RML.25.82R
91		RML.16.91R	RML.25.91R
100	RML.10.100R	RML.16.100R	RML.25.100R
110		RML.16.110R	RML.25.110R
120	RML.10.120R	RML.16.120R	RML.25.120R
130		RML.16.130R	RML.25.130R
150	RML.10.150R	RML.16.150R	RML.25.150R
160		RML.16.160R	RML.25.160R
180	RML.10.180R	RML.16.180R	RML.25.180R
200		RML.16.200R	RML.25.200R
220	RML.10.220R	RML.16.220R	RML.25.220R
240		RML.16.240R	RML.25.240R
270	RML.10.270R	RML.16.270R	RML.25.270R
300		RML.16.300R	RML.25.300R
330	RML.10.330R	RML.16.330R	RML.25.330R
360		RML.16.360R	RML.25.360R
390	RML.10.390R	RML.16.390R	RML.25.390R
430		RML.16.430R	RML.25.430R
470	RML.10.470R	RML.16.470R	RML.25.470R
510		RML.16.510R	RML.25.510R
560	RML.10.560R	RML.16.560R	RML.25.560R
620		RML.16.620R	RML.25.620R
680	RML.10.680R	RML.16.680R	RML.25.680R
750		RML.16.750R	RML.25.750R
820	RML.10.820R	RML.16.820R	RML.25.820R
910		RML.16.910R	RML.25.910R



Wert in Ω	Best.Nr.	Best.Nr.	Best.Nr.
	<b>1 Watt</b>	<b>2 Watt</b>	<b>3 Watt</b>
1k	RML.10.1K0	RML.16.1K0	RML.25.1K0
1.1k		RML.16.1K1	RML.25.1K1
1.2k	RML.10.1K2	RML.16.1K2	RML.25.1K2
1.3k		RML.16.1K3	RML.25.1K3
1.5k	RML.10.1K5	RML.16.1K5	RML.25.1K5
1.6k		RML.16.1K6	RML.25.1K6
1.8k	RML.10.1K8	RML.16.1K8	RML.25.1K8
2k		RML.16.2K0	RML.25.2K0
2.2k	RML.10.2K2	RML.16.2K2	RML.25.2K2
2.4k		RML.16.2K4	RML.25.2K4
2.7k	RML.10.2K7	RML.16.2K7	RML.25.2K7
3k		RML.16.3K0	RML.25.3K0
3.3k	RML.10.3K3	RML.16.3K3	RML.25.3K3
3.6k		RML.16.3K6	RML.25.3K6
3.9k	RML.10.3K9	RML.16.3K9	RML.25.3K9
4.3k		RML.16.4K3	RML.25.4K3
4.7k	RML.10.4K7	RML.16.4K7	RML.25.4K7
5.1k		RML.16.5K1	RML.25.5K1
5.6k	RML.10.5K6	RML.16.5K6	RML.25.5K6
6.2k		RML.16.6K2	RML.25.6K2
6.8k	RML.10.6K8	RML.16.6K8	RML.25.6K8
7.5k		RML.16.7K5	RML.25.7K5
8.2k	RML.10.8K2	RML.16.8K2	RML.25.8K2
9.1k		RML.16.9K1	RML.25.9K1
10k	RML.10.10K	RML.16.10K	RML.25.10K
11k		RML.16.11K	RML.25.11K
12k	RML.10.12K	RML.16.12K	RML.25.12K
13k		RML.16.13K	RML.25.13K
15k	RML.10.15K	RML.16.15K	RML.25.15K
16k		RML.16.16K	RML.25.16K
18k	RML.10.18K	RML.16.18K	RML.25.18K
20k		RML.16.20K	RML.25.20K
22k	RML.10.22K	RML.16.22K	RML.25.22K
24k		RML.16.24K	RML.25.24K
27k	RML.10.27K	RML.16.27K	RML.25.27K
30k		RML.16.30K	RML.25.30K
33k	RML.10.33K	RML.16.33K	RML.25.33K
36k		RML.16.36K	RML.25.36K
39k	RML.10.39K	RML.16.39K	RML.25.39K
43k		RML.16.43K	RML.25.43K
47k	RML.10.47K	RML.16.47K	RML.25.47K
51k		RML.16.51K	RML.25.51K
56k	RML.10.56K	RML.16.56K	RML.25.56K
62k		RML.16.62K	RML.25.62K
68k	RML.10.68K	RML.16.68K	RML.25.68K
75k		RML.16.75K	RML.25.75K
82k	RML.10.82K	RML.16.82K	RML.25.82K
91k		RML.16.91K	RML.25.91K
100k	RML.10.100K	RML.16.100K	RML.25.100K
110k		RML.16.110K	RML.25.110K
120k	RML.10.120K	RML.16.120K	RML.25.120K
130k		RML.16.130K	RML.25.130K
150k	RML.10.150K	RML.16.150K	RML.25.150K
160k		RML.16.160K	RML.25.160K
180k	RML.10.180K	RML.16.180K	RML.25.180K
200k		RML.16.200K	RML.25.200K
220k	RML.10.220K	RML.16.220K	RML.25.220K
240k		RML.16.240K	RML.25.240K
270k	RML.10.270K	RML.16.270K	RML.25.270K
300k		RML.16.300K	RML.25.300K
330k	RML.10.330K	RML.16.330K	RML.25.330K
360k		RML.16.360K	RML.25.360K
390k	RML.10.390K	RML.16.390K	RML.25.390K
430k		RML.16.430K	RML.25.430K
470k	RML.10.470K	RML.16.470K	RML.25.470K
510k		RML.16.510K	RML.25.510K
560k	RML.10.560K	RML.16.560K	RML.25.560K
620k		RML.16.620K	RML.25.620K
680k	RML.10.680K	RML.16.680K	RML.25.680K
750k		RML.16.750K	RML.25.750K
820k	RML.10.820K	RML.16.820K	RML.25.820K
910k		RML.16.910K	RML.25.910K
1M	RML.10.1M0	RML.16.1M0	RML.25.1M0



**Draht-Widerstände**

Diese Widerstände besitzen einen flexiblen Wickelkörper aus Fiberglasfäden, auf den der Widerstandsdraht mit gleichmässiger Steigung aufgebracht ist.

Die beiden Typen RDA.xxx und RDB.xxx sind durch einen hitzebeständigen Lacküberzug innerhalb eines Keramikkörpers. Dieser hat ausgezeichnete thermische Eigenschaften und eine hohe Durchschlagsfestigkeit (2000Veff), so dass diese Widerstände gefahrlos auf ein Metallchassis montiert werden können.





Thermeraturkoeffizient RDA.xxx: ±20ppm/K

Thermeraturkoeffizient restliche Typen: -80 bis +500ppm/K

<b>Toleranz</b>	± 10%	± 2%	± 5%	± 5%	± 5%	± 10% / ± 5%	± 10% / ± 5%
<b>Wert in Ω</b>	<b>Best.Nr.</b>	<b>Best.Nr.</b>	<b>Best.Nr.</b>	<b>Best.Nr.</b>	<b>Best.Nr.</b>	<b>Best.Nr.</b>	<b>Best.Nr.</b>
	<b>1 Watt</b>	<b>2 Watt</b>	<b>4 Watt</b>	<b>5 Watt</b>	<b>9 Watt</b>	<b>11 Watt</b>	<b>17 Watt</b>
0.1	RDB.R10	RDA.R10	RDE.R10				
0.12	RDB.R12	RDA.R12	RDE.R12	RDF.R12			
0.15	RDB.R15	RDA.R15	RDE.R15	RDF.R15			
0.18	RDB.R18	RDA.R18	RDE.R18	RDF.R18			
0.22	RDB.R22	RDA.R22	RDE.R22	RDF.R22			
0.27	RDB.R27	RDA.R27	RDE.R27	RDF.R27			
0.33	RDB.R33	RDA.R33	RDE.R33	RDF.R33	RDI.R33		
0.39	RDB.R39	RDA.R39	RDE.R39	RDF.R39	RDI.R39		
0.47	RDB.R47	RDA.R47	RDE.R47	RDF.R47	RDI.R47		
0.56	RDB.R56	RDA.R56	RDE.R56	RDF.R56	RDI.R56		
0.68	RDB.R68	RDA.R68	RDE.R68	RDF.R68	RDI.R68	RDL.R68	
0.82	RDB.R82	RDA.R82	RDE.R82	RDF.R82	RDI.R82	RDL.R82	
1	RDB.1R0	RDA.1R0	RDE.1R0	RDF.1R0	RDI.1R0	RDL.1R0	RDO.1R0
1.2	RDB.1R2	RDA.1R2	RDE.1R2	RDF.1R2	RDI.1R2	RDL.1R2	RDO.1R2
1.5	RDB.1R5	RDA.1R5	RDE.1R5	RDF.1R5	RDI.1R5	RDL.1R5	RDO.1R5
1.8	RDB.1R8	RDA.1R8	RDE.1R8	RDF.1R8	RDI.1R8	RDL.1R8	RDO.1R8
2.2	RDB.2R2	RDA.2R2	RDE.2R2	RDF.2R2	RDI.2R2	RDL.2R2	RDO.2R2
2.7	RDB.2R7	RDA.2R7	RDE.2R7	RDF.2R7	RDI.2R7	RDL.2R7	RDO.2R7
3.3	RDB.3R3	RDA.3R3	RDE.3R3	RDF.3R3	RDI.3R3	RDL.3R3	RDO.3R3
3.9	RDB.3R9	RDA.3R9	RDE.3R9	RDF.3R9	RDI.3R9	RDL.3R9	RDO.3R9
4.7	RDB.4R7	RDA.4R7	RDE.4R7	RDF.4R7	RDI.4R7	RDL.4R7	RDO.4R7
5.1					RDI.5R1		
5.6	RDB.5R6	RDA.5R6	RDE.5R6	RDF.5R6	RDI.5R6	RDL.5R6	RDO.5R6
6.8	RDB.6R8	RDA.6R8	RDE.6R8	RDF.6R8	RDI.6R8	RDL.6R8	RDO.6R8
8.2	RDB.8R2	RDA.8R2	RDE.8R2	RDF.8R2	RDI.8R2	RDL.8R2	RDO.8R2
10	RDB.10R		RDE.10R	RDF.10R	RDI.10R	RDL.10R	RDO.10R
12	RDB.12R		RDE.12R	RDF.12R	RDI.12R	RDL.12R	RDO.12R
15	RDB.15R		RDE.15R	RDF.15R	RDI.15R	RDL.15R	RDO.15R
18	RDB.18R		RDE.18R	RDF.18R	RDI.18R	RDL.18R	RDO.18R
22	RDB.22R		RDE.22R	RDF.22R	RDI.22R	RDL.22R	RDO.22R
27	RDB.27R		RDE.27R	RDF.27R	RDI.27R	RDL.27R	RDO.27R
33	RDB.33R		RDE.33R	RDF.33R	RDI.33R	RDL.33R	RDO.33R
39	RDB.39R		RDE.39R	RDF.39R	RDI.39R	RDL.39R	RDO.39R
47	RDB.47R		RDE.47R	RDF.47R	RDI.47R	RDL.47R	RDO.47R

Fortsetzung auf der nächsten Seite

**Draht-Widerstände** Fortsetzung

							
<b>Toleranz</b>	± 10%	± 2%	± 5%	± 5%	± 5%	± 10% / ± 5%	± 10% / ± 5%
Wert in Ω	Best.Nr.	Best.Nr.	Best.Nr.	Best.Nr.	Best.Nr.	Best.Nr.	Best.Nr.
	1 Watt	2 Watt	4 Watt	5 Watt	9 Watt	11 Watt	17 Watt
56	RDB.56R		RDE.56R	RDF.56R	RDI.56R	RDL.56R	RDO.56R
68	RDB.68R		RDE.68R	RDF.68R	RDI.68R	RDL.68R	RDO.68R
82	RDB.82R		RDE.82R	RDF.82R	RDI.82R	RDL.82R	RDO.82R
100	RDB.100R		RDE.100R	RDF.100R	RDI.100R	RDL.100R	RDO.100R
120	RDB.120R		RDE.120R	RDF.120R	RDI.120R	RDL.120R	RDO.120R
150	RDB.150R		RDE.150R	RDF.150R	RDI.150R	RDL.150R	RDO.150R
180	RDB.180R		RDE.180R	RDF.180R	RDI.180R	RDL.180R	RDO.180R
220	RDB.220R		RDE.220R	RDF.220R	RDI.220R	RDL.220R	RDO.220R
270	RDB.270R		RDE.270R	RDF.270R	RDI.270R	RDL.270R	RDO.270R
330	RDB.330R		RDE.330R	RDF.330R	RDI.330R	RDL.330R	RDO.330R
390	RDB.390R		RDE.390R	RDF.390R	RDI.390R	RDL.390R	RDO.390R
470	RDB.470R		RDE.470R	RDF.470R	RDI.470R	RDL.470R	RDO.470R
560	RDB.560R		RDE.560R	RDF.560R	RDI.560R	RDL.560R	RDO.560R
680	RDB.680R		RDE.680R	RDF.680R	RDI.680R	RDL.680R	RDO.680R
820	RDB.820R		RDE.820R	RDF.820R	RDI.820R	RDL.820R	RDO.820R
1k	RDB.1K0		RDE.1K0	RDF.1K0	RDI.1K0	RDL.1K0	RDO.1K0
1.2k	RDB.1K2		RDE.1K2	RDF.1K2	RDI.1K2	RDL.1K2	RDO.1K2
1.5k	RDB.1K5		RDE.1K5	RDF.1K5	RDI.1K5	RDL.1K5	RDO.1K5
1.8k	RDB.1K8		RDE.1K8	RDF.1K8	RDI.1K8	RDL.1K8	RDO.1K8
2.2k	RDB.2K2		RDE.2K2	RDF.2K2	RDI.2K2	RDL.2K2	RDO.2K2
2.7k	RDB.2K7		RDE.2K7	RDF.2K7	RDI.2K7	RDL.2K7	RDO.2K7
3.3k	RDB.3K3		RDE.3K3	RDF.3K3	RDI.3K3	RDL.3K3	RDO.3K3
3.6K				RDF.3K6			
3.9k	RDB.3K9		RDE.3K9	RDF.3K9	RDI.3K9	RDL.3K9	RDO.3K9
4.7k			RDE.4K7	RDF.4K7	RDI.4K7	RDL.4K7	RDO.4K7
5.6k			RDE.5K6	RDF.5K6	RDI.5K6	RDL.5K6	RDO.5K6
6.8k			RDE.6K8	RDF.6K8	RDI.6K8	RDL.6K8	RDO.6K8
8.2k			RDE.8K2	RDF.8K2	RDI.8K2	RDL.8K2	RDO.8K2
10k				RDF.10K	RDI.10K	RDL.10K	RDO.10K
12k				RDF.12K	RDI.12K	RDL.12K	RDO.12K
15k				RDF.15K	RDI.15K	RDL.15K	RDO.15K
18k					RDI.18K	RDL.18K	RDO.18K
22k					RDI.22K	RDL.22K	RDO.22K
27k					RDI.27K	RDL.27K	RDO.27K
33k					RDI.33K	RDL.33K	RDO.33K
39						RDL.39K	RDO.39K
47k						RDL.47K	RDO.47K
56k							RDO.56K
68k							RDO.68K
82k							RDO.82K

**Zubehör zu Draht-Widerstände**

Passend zu 4W, 5W, 9W, 11W und 17W-Drahtw iderstände

RDZ.133 = Chassis Befestigungsw inkel

RDZ.142 = Print-Stützbügel



Best.Nr.

RDZ.133

RDZ.142



**Draht-Widerstände ohne Abgriffschelle ±5%**

Toleranz: ±5%  
Marke: Ohmite, Serie 270

Abmessungen:

- 25 Watt** L=50.8mm (2") D=14.3mm (0.562")
- 50 Watt** L=101.6mm (4") D=14.3mm (0.562")
- 100 Watt** L=165.1mm (6.5") D=19.1mm (0.750")
- 225 Watt** L=266.7mm (10.5") D=28.6mm (1.125")



Wert in Ω	Best.Nr.	Ohmite Nr.	Watt
4	REL.25.4R0	L25J4R0	25
200	REL.25.200R	L25J200	
250	REL.25.250R	L25J250	
500	REL.25.500R	L25J250	
25k	REL.25.25k	L25J25K	
2	REL.50.2R0	L50J2R0	50
4	REL.50.4R0	L50J4R0	
75	REL.50.75R	L50J75R	
150	REL.50.150R	L50J150	
2k	REL.50.2K0	L50J2K0	
3k	REL.50.3K0	L50J3K0	
5k	REL.50.5K0	L50J5K0	
7.5k	REL.50.7K5	L50J7K5	100
25k	REL.50.25K	L50J25K	
50k	REL.50.50K	L50J50K	
1	REL.100.1R0	L100J1R0	
2	REL.100.2R0	L100J2R0	
3	REL.100.3R0	L100J3R0	
4	REL.100.4R0	L100J4R0	
100	REL.100.100R	L100J100	
150	REL.100.150R	L100J150	
1k	REL.100.1K0	L100J1K0	
2k	REL.100.2K0	L100J2K0	225
2.5k	REL.100.2K5	L100J2K5	
3k	REL.100.3K0	L100J3K0	
7.5k	REL.100.7K5	L100J7K5	
10k	REL.100.10K	L100J10K	
15k	REL.100.15K	L100J15K	
100k	REL.100.100K	L100J100K	
2	REL.225.2R0	L225J2R0	
150	REL.225.150R	L225J150	
250	REL.225.250R	L225J250	
500	REL.225.500R	L225J500	
1.5k	REL.225.1K5	L225J1K5	
2k	REL.225.2K0	L225J2K0	
3k	REL.225.3K0	L225J3K0	
5k	REL.225.5K0	L225J5K0	
20k	REL.225.20K	L225J20K	
50k	REL.225.50k	L225J50K	

**Draht-Widerstände mit Abgriffschelle ±10%**

Toleranz: ±10%  
Marke: Ohmite, Serie 210

Abmessungen:

- 12 Watt** L=44.4mm (1.75") D=7.94mm (0.313")
- 25 Watt** L=50.8mm (2") D=14.3mm (0.562")
- 50 Watt** L=101.6mm (4") D=14.3mm (0.562")
- 100 Watt** L=165.1mm (6.5") D=19.1mm (0.750")
- 160 Watt** L=160mm D=35mm (5% Toleranz)
- 225 Watt** L=266.7mm (10.5") D=28.6mm (1.125")
- 250 Watt** L=250mm D=35mm (5% Toleranz)



Wert in Ω	Best.Nr.	Ohmite Nr.	Watt
1	REL.AG.12.1R0	D12K1R0	12
2	REL.AG.12.2R0	D12K2R0	
3	REL.AG.12.3R0	D12K3R0	
5	REL.AG.12.5R0	D12K5R0	
10	REL.AG.12.10R	D12K10R	
25	REL.AG.12.25R	D12K25R	25
50	REL.AG.12.50R	D12K50R	
150	REL.AG.12.150R	D12K150	
250	REL.AG.12.250R	D12K250	
5k	REL.AG.12.5K	D12K5K0	
10k	REL.AG.12.10K	D12K10K	50
1	REL.AG.25.1R0	D25K1R0	
1.5k	REL.AG.25.1K5	D25K1K5	
2.5k	REL.AG.25.2K5	D25K2K5	
10k	REL.AG.25.10K	D25K10K	
3	REL.AG.50.3R0	D50K3R0	100
75	REL.AG.50.75R	D50K75R	
10k	REL.AG.50.10K	D50K10K	
50k	REL.AG.50.50K	D50K50K	
100k	REL.AG.50.100K	D50K100K	
3	REL.AG.100.3R0	D100K3R0	160
5	REL.AG.100.5R0	D100K5R0	
5k	REL.AG.100.5K0	D100K5K0	
27	REL.AG.160.27R	Philips	225
2	REL.AG.225.2R0	D225K2R0	
3	REL.AG.225.3R0	D225K3R0	
100	REL.AG.225.100R	D225K100	250
500	REL.AG.225.500R	D225K500	
27	REL.AG.250.27R	Philips	
1.2k	REL.AG.250.1k2	Philips	

**Draht-Widerstände in Alugehäuse ±5%**

**25 Watt** Belastbarkeit @ 25°C (gekühlt): 20W (P25), (ungekühlt): 8W

**50 Watt** Belastbarkeit @ 25°C (gekühlt): 30 - 50W (P25), (ungekühlt): 10W

**100 Watt** Belastbarkeit @ 25°C (gekühlt): 100W (P25), (ungekühlt): 50W



**25 Watt**



**50 Watt**



**100 Watt**

Wert in Ω	Best.Nr.	Best.Nr.	Best.Nr.
	<b>25 Watt</b>	<b>50 Watt</b>	<b>100 Watt</b>
0.1	<a href="#">RHS.25.R10</a>	<a href="#">RHS.50.R10</a>	
0.12	<a href="#">RHS.25.R12</a>	<a href="#">RHS.50.R12</a>	
0.15	<a href="#">RHS.25.R15</a>	<a href="#">RHS.50.R15</a>	
0.18	<a href="#">RHS.25.R18</a>	<a href="#">RHS.50.R18</a>	
0.22	<a href="#">RHS.25.R22</a>	<a href="#">RHS.50.R22</a>	
0.27	<a href="#">RHS.25.R27</a>	<a href="#">RHS.50.R27</a>	
0.33	<a href="#">RHS.25.R33</a>	<a href="#">RHS.50.R33</a>	
0.39	<a href="#">RHS.25.R39</a>	<a href="#">RHS505.R39</a>	
0.47	<a href="#">RHS.25.R47</a>	<a href="#">RHS.50.R47</a>	
0.56	<a href="#">RHS.25.R56</a>	<a href="#">RHS.50.R56</a>	
0.68	<a href="#">RHS.25.R68</a>	<a href="#">RHS.50.R68</a>	
0.82	<a href="#">RHS.25.R82</a>	<a href="#">RHS.50.R82</a>	
1	<a href="#">RHS.25.R10</a>	<a href="#">RHS.50.R10</a>	<a href="#">RHS.100.1R0</a>
1.2	<a href="#">RHS.25.1R2</a>	<a href="#">RHS.50.1R2</a>	
1.5	<a href="#">RHS.25.1R5</a>	<a href="#">RHS.50.1R5</a>	<a href="#">RHS.100.1R5</a>
1.8	<a href="#">RHS.25.1R8</a>	<a href="#">RHS.50.1R8</a>	
2.2	<a href="#">RHS.25.2R2</a>	<a href="#">RHS.50.2R2</a>	<a href="#">RHS.100.2R2</a>
2.7	<a href="#">RHS.25.2R7</a>	<a href="#">RHS.50.2R7</a>	
3.3	<a href="#">RHS.25.3R3</a>	<a href="#">RHS.50.3R3</a>	<a href="#">RHS.100.3R3</a>
3.9	<a href="#">RHS.25.3R9</a>	<a href="#">RHS.50.3R9</a>	
4.7	<a href="#">RHS.25.4R7</a>	<a href="#">RHS.50.4R7</a>	<a href="#">RHS.100.4R7</a>
5.6	<a href="#">RHS.25.5R6</a>	<a href="#">RHS.50.5R6</a>	
6.8	<a href="#">RHS.25.6R8</a>	<a href="#">RHS.50.6R8</a>	<a href="#">RHS.100.6R8</a>
8.2	<a href="#">RHS.25.8R2</a>	<a href="#">RHS.50.8R2</a>	
10	<a href="#">RHS.25.10R</a>	<a href="#">RHS.50.10R</a>	<a href="#">RHS.100.10R</a>
12	<a href="#">RHS.25.12R</a>	<a href="#">RHS.50.12R</a>	
15	<a href="#">RHS.25.15R</a>	<a href="#">RHS.50.15R</a>	<a href="#">RHS.100.15R</a>
18	<a href="#">RHS.25.18R</a>	<a href="#">RHS.50.18R</a>	
22	<a href="#">RHS.25.22R</a>	<a href="#">RHS.50.22R</a>	<a href="#">RHS.100.22R</a>
27	<a href="#">RHS.25.27R</a>	<a href="#">RHS.50.27R</a>	
33	<a href="#">RHS.25.33R</a>	<a href="#">RHS.50.33R</a>	<a href="#">RHS.100.33R</a>

Wert in Ω	Best.Nr.	Best.Nr.	Best.Nr.
	<b>25 Watt</b>	<b>50 Watt</b>	<b>100 Watt</b>
100	<a href="#">RHS.25.100R</a>	<a href="#">RHS.50.100R</a>	<a href="#">RHS.100.100R</a>
120	<a href="#">RHS.25.120R</a>	<a href="#">RHS.50.120R</a>	
150	<a href="#">RHS.25.150R</a>	<a href="#">RHS.50.150R</a>	<a href="#">RHS.100.150R</a>
180	<a href="#">RHS.25.180R</a>	<a href="#">RHS.50.180R</a>	
220	<a href="#">RHS.25.220R</a>	<a href="#">RHS.50.220R</a>	<a href="#">RHS.100.220R</a>
270	<a href="#">RHS.25.270R</a>	<a href="#">RHS.50.270R</a>	
330	<a href="#">RHS.25.330R</a>	<a href="#">RHS.50.330R</a>	<a href="#">RHS.100.330R</a>
390	<a href="#">RHS.25.390R</a>	<a href="#">RHS.50.390R</a>	
470	<a href="#">RHS.25.470R</a>	<a href="#">RHS.50.470R</a>	<a href="#">RHS.100.470R</a>
560	<a href="#">RHS.25.560R</a>	<a href="#">RHS.50.560R</a>	
680	<a href="#">RHS.25.680R</a>	<a href="#">RHS.50.680R</a>	<a href="#">RHS.100.680R</a>
820	<a href="#">RHS.25.820R</a>	<a href="#">RHS.50.820R</a>	
1k	<a href="#">RHS.25.1K0</a>	<a href="#">RHS.50.1K0</a>	<a href="#">RHS.100.1K0</a>
1.2k	<a href="#">RHS.25.1K2</a>	<a href="#">RHS.50.1K2</a>	
1.5k	<a href="#">RHS.25.1K5</a>	<a href="#">RHS.50.1K5</a>	<a href="#">RHS.100.1K5</a>
1.8k	<a href="#">RHS.25.1K8</a>	<a href="#">RHS.50.1K8</a>	
2.2k	<a href="#">RHS.25.2K2</a>	<a href="#">RHS.50.2K2</a>	<a href="#">RHS.100.2K2</a>
2.7k	<a href="#">RHS.25.2K7</a>	<a href="#">RHS.50.2K7</a>	
3.3k	<a href="#">RHS.25.3K3</a>	<a href="#">RHS.50.3K3</a>	<a href="#">RHS.100.3K3</a>
3.9k	<a href="#">RHS.25.3K9</a>	<a href="#">RHS.50.3K9</a>	
4.7k	<a href="#">RHS.25.4K7</a>	<a href="#">RHS.50.4K7</a>	<a href="#">RHS.100.4K7</a>
5.6k	<a href="#">RHS.25.5K6</a>	<a href="#">RHS.50.5K6</a>	
6.8k	<a href="#">RHS.25.6K8</a>	<a href="#">RHS.50.6K8</a>	<a href="#">RHS.100.6K8</a>
8.2k	<a href="#">RHS.25.8K2</a>	<a href="#">RHS.50.8K2</a>	
10k	<a href="#">RHS.25.10K</a>	<a href="#">RHS.50.10K</a>	<a href="#">RHS.100.10K</a>
12k	<a href="#">RHS.25.12K</a>		
15k	<a href="#">RHS.25.15K</a>		
18k	<a href="#">RHS.25.18K</a>		
22k	<a href="#">RHS.25.22K</a>		
27k	<a href="#">RHS.25.27K</a>		
33k	<a href="#">RHS.25.33K</a>		

**Widerstands-Netzwerke single-in-line**

Anschlüsse: SIL (single-in-line)  
 Belastbarkeit @ Tamb 70°C: 0.125W/Element  
 Belastbarkeit @ Tamb 70°C: 1.0W/Netzwerk  
 Betriebsspannung: <100VRMS  
 Spannungsfestigkeit: <250VRMS  
 Toleranz: ±5.0%  
 Temperaturkoeffizient: ±200ppm°C

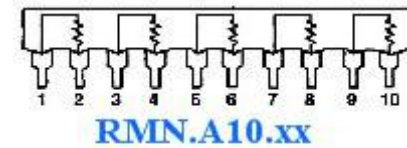
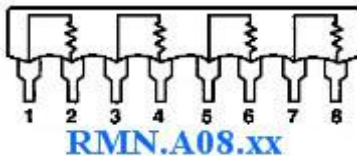
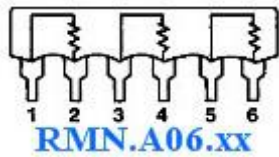
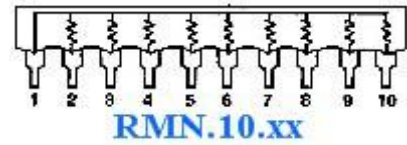
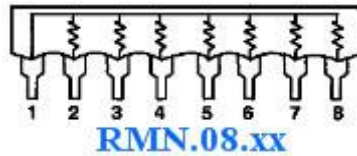
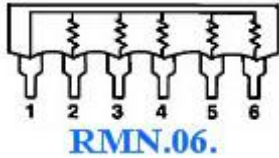

Wert in Ω	Best.Nr.	Best.Nr.	Best.Nr.
	<b>5 Elemente</b>	<b>7 Elemente</b>	<b>9 Elemente</b>
Elemente mit gemeinsamem Anschluss			
47	RMN.06.47R	RMN.08.47R	RMN.10.47R
56	RMN.06.56R	RMN.08.56R	RMN.10.56R
68	RMN.06.68R	RMN.08.68R	RMN.10.68R
100	RMN.06.100R	RMN.08.100R	RMN.10.100R
150	RMN.06.150R	RMN.08.150R	RMN.10.150R
220	RMN.06.220R	RMN.08.220R	RMN.10.220R
270	RMN.06.270R		
330	RMN.06.330R	RMN.08.330R	RMN.10.330R
390	RMN.06.390R		
470	RMN.06.470R	RMN.08.470R	RMN.10.470R
560	RMN.06.560R		
680	RMN.06.680R	RMN.08.680R	RMN.10.680R
1k	RMN.06.1K0	RMN.08.1K0	RMN.10.1K0
1.5k	RMN.06.1K5	RMN.08.1K5	RMN.10.1K5
2.2k	RMN.06.2K2	RMN.08.2K2	RMN.10.2K2
3.3k	RMN.06.3K3	RMN.08.3K3	RMN.10.3K3
3.9k		RMN.08.3K9	
4.7k	RMN.06.4K7	RMN.08.4K7	RMN.10.4K7
5.6k			
6.8k	RMN.06.6K8	RMN.08.6K8	RMN.10.6K8
10k	RMN.06.10K	RMN.08.10K	RMN.10.10K
15k	RMN.06.15K	RMN.08.15K	RMN.10.15K
22k	RMN.06.22K	RMN.08.22K	RMN.10.22K
27k	RMN.06.27K		
33k	RMN.06.33K	RMN.08.33K	RMN.10.33K
47k	RMN.06.47K	RMN.08.47K	RMN.10.47K
68k	RMN.06.68K	RMN.08.68K	RMN.10.68K
82k			
100k	RMN.06.100K	RMN.08.100K	RMN.10.100K
150k	RMN.06.150K	RMN.08.150K	RMN.10.150K
220k	RMN.06.220K	RMN.08.220K	RMN.10.220K
330k	RMN.06.330K	RMN.08.330K	RMN.10.330K
470k	RMN.06.470K	RMN.08.470K	RMN.10.470K
680k	RMN.06.680K	RMN.08.680K	RMN.10.680K
1M	RMN.06.1M0	RMN.08.1M0	RMN.10.1M0

Wert in Ω	Best.Nr.	Best.Nr.	Best.Nr.
	<b>3 Elemente</b>	<b>4 Elemente</b>	<b>5 Elemente</b>
Elemente mit individuellem Anschluss			
47	RMN.A06.47R	RMN.A08.47R	RMN.A10.47R
56			
68	RMN.A06.68R	RMN.A08.68R	RMN.A10.68R
100	RMN.A06.100R	RMN.A08.100R	RMN.A10.100R
150	RMN.A06.150R	RMN.A08.150R	RMN.A10.150R
220	RMN.A06.220R	RMN.A08.220R	RMN.A10.220R
270		RMN.A08.270R	
330	RMN.A06.330R	RMN.A08.330R	RMN.A10.330R
390			
470	RMN.A06.470R	RMN.A08.470R	RMN.A10.470R
560			
680	RMN.A06.680R	RMN.A08.680R	RMN.A10.680R
1k	RMN.A06.1K0	RMN.A08.1K0	RMN.A10.1K0
1.5k	RMN.A06.1K5	RMN.A08.1K5	RMN.A10.1K5
2.2k	RMN.A06.2K2	RMN.A08.2K2	RMN.A10.2K2
3.3k	RMN.A06.3K3	RMN.A08.3K3	RMN.A10.3K3
4.7k	RMN.A06.4K7	RMN.A08.4K7	RMN.A10.4K7
5.6k		RMN.A08.5K6	
6.8k	RMN.A06.6K8	RMN.A08.6K8	RMN.A10.6K8
10k	RMN.A06.10K	RMN.A08.10K	RMN.A10.10K
15k	RMN.A06.15K	RMN.A08.15K	RMN.A10.15K
22k	RMN.A06.22K	RMN.A08.22K	RMN.A10.22K
27k			RMN.A10.27K
33k	RMN.A06.33K	RMN.A08.33K	RMN.A10.33K
47k	RMN.A06.47K	RMN.A08.47K	RMN.A10.47K
68k	RMN.A06.68K	RMN.A08.68K	RMN.A10.68K
82k		RMN.A08.82K	
100k	RMN.A06.100K	RMN.A08.100K	RMN.A10.100K
150k	RMN.A06.150K	RMN.A08.150K	RMN.A10.150K
220k	RMN.A06.220K	RMN.A08.220K	RMN.A10.220K
330k	RMN.A06.330K	RMN.A08.330K	RMN.A10.330K
470k	RMN.A06.470K	RMN.A08.470K	RMN.A10.470K
680k	RMN.A06.680K	RMN.A08.680K	RMN.A10.680K
1M	RMN.A06.1M0	RMN.A08.1M0	RMN.A10.1M0